

Cortex for Corial **User's Guide**



English edition December 2021

CONTENTS

Notices.....	9
User qualifications and safety.....	9
Copyright and legal notices.....	9
Contact information.....	10
Welcome to Cortex for Corial	11
Starting Cortex and logging in.....	13
Stopping and restarting Cortex.....	14
Understanding the startup process.....	14
Setting the system focus.....	16
Creating and managing user accounts	18
Setting up user accounts.....	18
Setting up automatic log-out for user accounts	20
Controlling access to features.....	21
Working with security tags	21
Using Help in Cortex	25
Navigating in Help.....	26
Displaying Release Notes	26
Updating and using Help outside Cortex.....	26
System documentation.....	27
Cortex documentation.....	27
Other documentation	27
Cortex interface overview.....	28
Main parts of the Cortex interface	28
Standards of the interface	29
Signal tower status indicators.....	32
The Status bar	33
Tool and software information	33
System messages and alerts (alarms and warnings)	33
User Login and current user	34
Abort button and task list	35

Signal tower	36
Other status indicators	36
Factory automation icons	37
Navigating to menus and screens	38
Selecting menus and screens	38
Availability of menus and screens	39
Menus and screen functions	41
Available functions for individual users	43
Applying commands with Context buttons	44
Creating process recipes	45
Interactive recipe development	46
Viewing recipes in tabular form	46
Adjusting tolerance, ramping, and morphing	48
Using recipe categories	50
Assigning recipes to categories	50
Using the standard and Personal recipe categories	51
Controlling user access to categories	52
Overview of process recipes	54
Recipe step types and settings	56
Overview of step types	56
Initial step settings	57
End step settings	58
Process step settings	58
Options for the duration of Process steps	60
Ramping of parameter changes	63
Setting up repeating process step sequences (looping)	64
Temperature step settings	67
Evacuation step settings	67
List of recipe parameters and settings	68
Options that can affect process parameters	72
Tolerance and timeout settings	73
Overriding tolerance values in recipes	74
Setting default tolerance and timeout values	75
Adjusting parameters in loop sequences	77

Parameter Morphing definitions.....	77
Setting the rate of change.....	78
TransFlex™ ramping of process parameters	80
Using the TransFlex chart.....	81
Basic ramping compared to TransFlex	83
Pulsing of process parameters.....	85
Setting up pulsing in a Process step	85
Defining a pulse cycle.....	87
Adjusting recipes interactively	90
Starting interactive processing.....	90
Overview of interactive processing.....	91
Using the Interactive screen	92
Changing process parameters.....	93
Charting process parameters	94
Exporting recipes	96
About PDF files	97
Using Auto Clean & Prep (ACAP).....	98
Examples of ACAP actions.....	98
ACAP terms and concepts.....	98
Selecting triggers and actions	100
Triggers and trigger parameters	101
Actions and action parameters	102
Resetting ACAP counters	104
Overview of processing features and methods.....	106
Using recipes for processing	106
Manual processing.....	106
Interactive processing.....	106
Monitoring, charting, and other processing features.....	107
Disabling and enabling the process module.....	107
Running process jobs	109
Processing with recipes.....	109
Material, vacuum, and temperature control.....	110
Monitoring and controlling jobs.....	111
Setup and operation of the load lock.....	113
Using the load lock.....	113

Testing material transfer mechanisms	115
Transfer mechanism settings	116
Setting transfer arm positions.....	117
I/O signals	119
Processing in Manual Mode.....	121
The Manual Mode screen	121
Identifying and resolving alarms	124
How Cortex displays alerts.....	124
Responding to warnings and alarms	125
Resolving alerts during processing	126
Creating charts with process data.....	128
Plotting live process data	129
Customizing charts.....	130
Selecting 'favorite' parameters	131
Creating charts of saved process data	133
Creating data charts.....	134
Creating 'ad hoc' charts from system data.....	134
Customizing charts.....	135
Zooming, scrolling, and displaying values	136
Displaying the alarms history.....	139
Sorting and filtering the alarm list.....	139
Setting the maximum alarm history size	141
Viewing job information and system data	142
Location of the Logs folder.....	142
Packaging log files.....	143
Viewing job history information.....	143
Viewing system usage data (gas, wafers, RF, ACAP).....	146
Viewing the user login history.....	147
Exporting process data	149
Vacuum leak testing	152
Viewing leak testing data	153
Vacuum system service controls.....	155
Unlocking the vacuum controls.....	155

The vacuum startup state and starting the pumps	156
Changing the vacuum system state	156
Vacuum screen diagrams and controls	158
Gas system service and maintenance	160
Using the gas system diagram.....	160
Operating gas channels.....	162
Evacuating and flushing gas lines.....	163
Cathode lift and helium cooling controls	165
Operating the cathode lift.....	165
Operating the helium circuit	166
Helium settings and I/O signals.....	167
Monitoring I/O signals	169
I/O signal types and values	169
Overriding I/O signals	171
Displaying I/O signals on graphs	173
Cortex installation and license keys	175
About the Cortex program installation	175
Additional software	175
Software license verification.....	176
Locations of settings and log files	176
System configuration	180
Reviewing system configuration settings.....	180
Saving system configuration settings	181
Importing a system configuration	182
List of System Configuration tabs and settings.....	182
Configuration of gas channels.....	188
Gas channel settings	188
Setting up forbidden gas pairs	189
Liquid precursor channels.....	190
Tool settings	191
Navigating and selecting tool settings.....	191
Identifying default and protected settings.....	192
Backing up tool settings	193
Factory automation commands and control states	194
Specialized messages	194

S2,F41 — HCS (Host Command Send)	194
S2,F42 — HCS Reply	196
S2,F71 Get Recipe List.....	197
Factory automation requirements	199
Control and communication states	199
Factory automation configuration	202
Settings in the 'Gem Interface.xml' file	202
Additional documentation	203

Notices

User qualifications and safety

The information and instructions in the documentation supplied with the Corial hardware and software must be followed to ensure that the system is operated in accordance with its intended use and purpose.

This documentation is intended only for technically qualified personnel who have been specially instructed by Corial or who have received appropriate training on the system. The training must have been specifically authorized by Corial. Only appropriately trained personnel are in a position to correctly interpret and implement the safety regulations contained in the system documentation. Personnel who have not been trained or who have not received authorized training on the system are not considered as authorized working personnel. Unauthorized personnel are not permitted to carry out any kind of work on the system. Plasma-Therm declines all liability for any claims for damages which occur when stipulations are disregarded. Plasma-Therm offers standard and user-tailored training for Corial products. The training team will be pleased to provide you with further information. See "Contact information," below, for address, telephone, and web contact information.

You must read the operating instructions manual prior to performing any work with the Corial system. It contains important information that is significant for your own personal safety. The documentation must have been read and understood by all persons who perform any kind of work on or with the system during any stage of its serviceable life.

Copyright and legal notices

Cortex Corial documentation copyright © 2019-2021 by Plasma-Therm LLC. All rights reserved.

This material may not be copied or distributed in printed or electronic form without express written permission of Plasma-Therm LLC.

The Cortex Control System software and other Plasma-Therm software that was originally installed on the Corial system may be used only with the equipment on which it was installed. It is strictly forbidden to make copies or give the software to third parties.

The use of trademarks, brand names, etc. in this document does not entitle third parties to consider these names to be unprotected.

Specifications and documentation are subject to change without notice.

Comments

We appreciate customer feedback about our systems and documentation. Customers can contact their sales or customer support representative, or write directly to custfocus@plasmatherm.com to provide comments. For technical help, please contact customer support at techsupport@plasmatherm.com.

Contact information

Corial

266 chemin des Franques
38190 Bernin
France

Phone: +33 4 76 01 10 10

Web: Corial.com

Plasma-Therm

10050 16th St. N
St. Petersburg, FL 33716
USA

Phone: (727) 577-4999

Fax: (727) 577-7035

Web: www.plasmatherm.com

Customer portal: <https://info.plasmatherm.com>

CCOH-EN-2021-1201

Welcome to Cortex for Corial

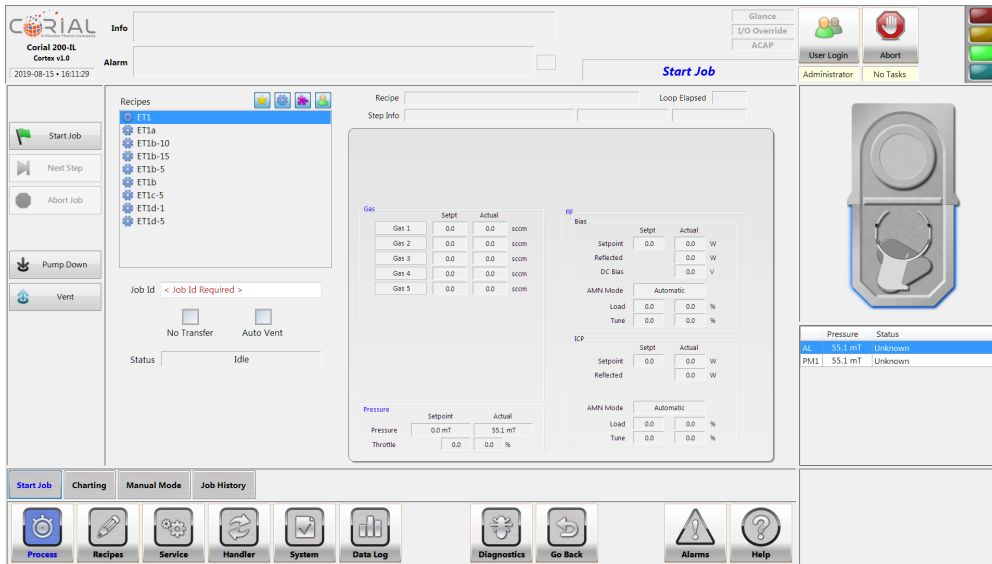

The Start Job screen appears when Cortex is initialized.

Cortex® is a unified system control program for all Corial systems. Cortex provides a modern, standards-compliant interface for operators, engineers and technicians to create recipes, start and monitor jobs, manage data, and perform service and maintenance routines.

System type and Cortex version

To view the system type and Cortex version, look upper-left of the screen in the [Status bar](#).



System name and Cortex version in the Status bar.

Corial models include plasma etching and deposition systems in three model series:

- 200 series: Compact models designed for lab and low-volume use, including R&D and failure analysis.
- 300 and 500 Series: Systems designed for 24/7 production environments.

Corial systems have either manual loading or a vacuum load port ("load lock").

Symbols and conventions

In the Help topics, individual screens are often referred to by listing the menu name followed by a colon and the screen name. For example

On the Process: Start Job screen...

This identifies the Start Job screen as being available from the Process menu button. For more information, see "Navigating to menus and screens."

Starting Cortex and logging in

When the system's main power is turned on, Windows starts up on the system computer, and then the default user is automatically logged in. Procedures for starting, stopping and logging in to Cortex are discussed next.

To start Cortex

1. Double-click the Cortex icon on the Windows desktop.
2. When the system is initialized, the **Startup** button appears. Click **Startup**.

A user can log in to the system before or after clicking **Startup**. A user must log in to proceed past the startup screen.

To log in to Cortex

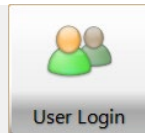

When Cortex starts, a user can log in once the **User Login** button is blinking in the status bar. At the end of the startup sequence, Cortex waits for a user to log in before displaying the Start Job screen.

1. Click **User Login**.
2. In the Log In/Out dialog box, select a user and type the account password in the Password box.
3. Click **Log In**.

When a user is logged in, the user's name appears below the **Log In** button.

Switching users and logging out

Logging out is recommended to prevent unauthorized access whenever a user finishes working at the system.

To log out

1. Click **User Login**.
2. Click **Log Out**. Cortex displays the startup screen, and no user is logged in.

To change the logged-in user

1. Select the user's name and type the account password.
2. Click **Log In**.

Stopping and restarting Cortex

Stopping and restarting Cortex may be required for computer maintenance, system upgrades, and configuration changes. Note that user account [security settings](#) determine whether a user can stop Cortex.

For safety reasons when shutting down, Cortex isolates process modules from the pump train, but does not turn off the system's pumps.

To stop Cortex

1. Before stopping Cortex, verify that no tasks are active:
 - Be sure that no process jobs are active. The green [signal light](#) blinks during processing.
 - "No Tasks" should appear below the **Abort** button.
 - No other activity, such as leak testing or manual operation, should be active.
 - Active alarms do not prevent shutting down Cortex.
2. Click **System: Exit**. The click **Shut Down** in the main panel.
3. If any tasks are active, a message asks if you want to exit anyway. Do either of the following:
 - Click **Cancel** to keep Cortex running.
 - To exit Cortex, click **OK**.







Active tasks at shutdown

Tasks that are in progress when Cortex is shut down will not be completed. Incomplete processing jobs may not be shown in the system logs and Job History screen. Material that is left in a process module or other location may have to be transferred manually when Cortex is restarted.

Understanding the startup process

When Cortex starts, the program window shows a listing of system components. Green indicator lights and messages show when Cortex establishes communication with components.

Bringing I/O on-line...

Module	I/O On-Line	Robotics On-Line	Mapped	Activities
PM1				Starting Modbus/TCP
AL				Starting Modbus/TCP

Status indicators on the Startup screen

The following status messages appear in sequence above the startup status table:

- **Bringing I/O on-line...**

This message indicates that the system network is initializing.

- **Robotics initialized**

This message appears only if the system includes cassette or transfer robotics.

- **Ready to Start System or System Ready!**

The Ready message appears if no user is logged in. "System Ready!" appears if a user is logged in.

If a hardware or communication problem occurs at startup, the status table shows the affected subsystem.

Bypassing the mapping process



When a user logs while Cortex is starting and initializing the system, the **Bypass** button appears (if the user's account settings do not prevent it). Clicking **Bypass** causes Cortex to skip mapping the system. This gives access to service and maintenance functions without waiting for mapping.

Setting the system focus

In Cortex, the *system focus* is always set to one of the tool's modules. On Corial load lock systems, the focus is on AL (the load module), or PM1, the process module. The focus is indicated by a blue outline.

To set the system focus

Click the module on the system graphic, or click the module name in the table.

Cortex indicates the current focus in two ways:

- The module that has focus is outlined in blue on the system graphic.
- In the table below the graphic, the name of the module that has focus is highlighted.

The system graphic and table below it are always displayed. The table below the system graphic lists the pressure and status of each module.

How the focus affects screens and actions

For some operations, the system focus must be set on the module to be acted on. If a screen is not available because of the current system focus, the main panel displays a message, such as "[screen name] is not available for the AL module."

Many operations do not depend on the system focus. The focus does not need to be set to use the Start Job and Manual Mode screens, for example.

The following are some effects of changing system focus:

- The available parameters on the Charting screen depend on which module has the system focus.
- On the [Vacuum System](#) screen, the main panel shows the components of the module that has focus.
- On most Service menu screens, the functions are available only if the process module has focus.
- The I/O screen displays input and output signals for the module that has focus.
- A [Leak Test](#) can be run only on the process module.

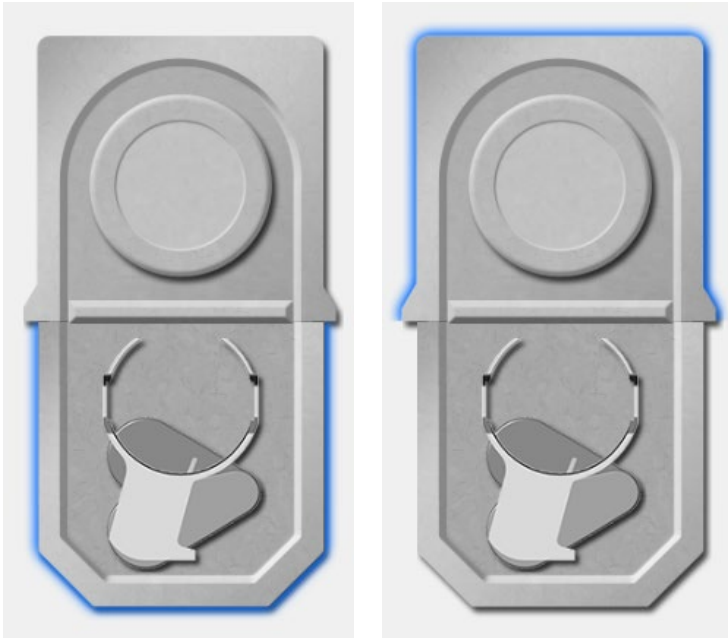

Focus on AL (left) and PM1 (right).

Creating and managing user accounts

User accounts can help prevent unauthorized access to the Corial system. Cortex tracks activities, and controls access to screens, commands, and process recipes based on user accounts.

The **User Management** screen includes commands for creating and removing accounts, and [controlling access](#) to Cortex features. By default, only the built-in Administrator account can use the User Management screen. You must log in using the Administrator account (or one with the same security settings) to create user accounts, or change [security settings](#).

The **User Log** screen shows user activity. The screen displays the time and date when each user logs in and logs out of the system. An interface log records the buttons and screens that are clicked by the logged-in user.

Setting up user accounts

User accounts are necessary for individuals to log in to the control system, and for tracking system use. Each user should have a unique user account name and password.

- **User names** can be 1 to 39 characters long, with uppercase and lowercase, numbers, punctuation and symbols (such as \$, %, and !).
- **Passwords** can be 1 to 16 characters long. Passwords are not case-sensitive.

There are two ways to create user accounts:

- **New user settings:** Accounts created by the **New User** command have no unlocked security tags; an administrator must unlock security tags to give the account access to screens and commands.
- **Cloning account settings:** The **Clone User** command creates a new account with the same security settings as a built-in account or any existing account.

To create a new account

1. Click **System > User Management** to go to the User Management screen.
2. Click **New User**. The Add New User dialog box appears.
3. Type a name and password for the new account, and then click **Create**. If the repeated password is not correct, the **Create** button is not available.
4. All [security tags](#) are locked for the new account. Select the tags to unlock and click **Unlock Selected** to grant access to menus and screens.
5. Click **Save Config** to save all current user account settings.





To clone an account

This procedure copies security and Auto-Logout settings to a new account.

1. On the User Management screen, select the account whose settings you want to copy to a new account. The Security Tags list shows the locked and unlocked security tags for the selected account.
2. Click **Clone User**. In the dialog box that appears, enter a user name, and type a password for the account in the Password and Repeat Password boxes.
3. Click **Clone**. The new user name appears in the Users list.
4. Click **Save Config** to save all current user account settings.

To change an account password

1. On the User Management screen, select the user account you want to change.
2. Click **Change Password**, and then type the new password in both boxes in the dialog box.
3. Click **Change Password**. A message confirms that the password has been changed. Click **OK** to close the message.
4. Click **Save Config** to save all current user account settings.

Users	Security Tags
Administrator	Menu: Alarm
Bob	Screen: Alarm
Chidi A	Screen: Alarm History
David H	Menu: Back
Eleanor	Menu: Datalog
Engineering	Screen: View Data Log
FabMgr	Button: View Select Data
Gaston L	Button: View Select Parameters
Guest	Button: View Export To CSV
Jack Daniels	Button: View Toggle Flags
Jason M	Button: View Toggle Markers
Jorge A	Menu: Diagnostics
Lab	Screen: Debug Log
Maintenance	Screen: Variables
Mekhi	 Screen: Managers
Michael	 Screen: Task Log
MS	 Screen: Sequencer
Operator	 Button: Diag Seq Step Mode

The Users box lists account names. When an account is selected, its settings appear in the Security Tags box.

Setting up automatic log-out for user accounts

The screenshot shows a user account configuration window. At the top, the 'Full Name' field contains 'Joseph Bartolo'. Below it, the 'Notes' field contains the text: 'First shift supervisor - Administrator role access; account created 2012-0815. Contact info joeb@gmail.com / 712-375-8949'. At the bottom, the 'Auto-Logout' field is set to '60' minutes, with a note '(0 = disabled)'.

User accounts can be set to automatically log out of Cortex after a specified period of inactivity. The Auto-Logout feature can provide additional security by preventing accounts that have broad access from remaining logged in after a specified period of inactivity.

When an account name is selected in the Users list, the Auto-Logout setting is available in the account details box. To set up automatic logout, enter the inactivity period in minutes until the account is logged out. Setting the value to zero disables automatic logout.

The default Auto-Logout value for new user accounts is 0 minutes, which disables automatic log-out. The maximum auto-logout value that can be entered is 9,999 minutes, which is just less than seven days.

When accounts are created with the Clone User feature, the Auto-Logout value is copied from the source account to the new account.

User Name	Login	Logout	Duration
Lab	9/9/2019 1:36:03 PM	9/9/2019 3:36:12 PM	2:00:09
Lab	9/9/2019 4:17:32 PM	9/9/2019 8:13:19 PM	3:55:48
Lab	9/10/2019 9:13:53 AM	9/10/2019 9:56:53 AM	43:00
Administrator	9/10/2019 9:56:53 AM	9/10/2019 9:58:43 AM	1:49
Lab	9/10/2019 9:58:43 AM	9/10/2019 10:00:52 AM	2:08
Maintenance	9/10/2019 10:00:52 AM	9/10/2019 10:05:38 AM	4:45
Lab	9/10/2019 10:05:38 AM	9/10/2019 12:10:51 PM	2:05:13

The User Log screen lists when users log in and log out of Cortex.

Controlling access to features

An administrator can enable and restrict access to Cortex features by configuring the *security tags* in each [user account](#). Every menu, screen, context button, and recipe category has a security tag. Each security tag can be locked or unlocked for any user account. Only the Administrator account cannot be changed.

A menu button appears in Cortex only if its security tag is unlocked in a user's account. For example, if the "Menu: Recipes" tag is locked, the Recipes menu button doesn't appear, and the user can't display the Edit Recipe screen. If a menu button is locked, none of its associate screen buttons appear in Cortex.

To set up security tags for user accounts, click the **System: User Management**. On the User Management screen, you can check security settings for user accounts, and change security settings.

To review or change security settings

1. On the **User Management** screen, select a user account. Only one account can be selected at a time.
2. The Security Tags list shows locked and unlocked security tags. To change security settings, select one or more security tags:
 - To select a series of tags, hold down SHIFT and click the first and last tag.
 - To select multiple individual tags, hold down CTRL and click each tag.
3. To change the selected tags' settings, do any of the following:
 - Click **Lock Selected** to lock the selected tags. If only one tag is selected, click **Lock**.
 - Click **Unlock selected** for multiple tags. If only one tag is selected, click **Unlock**.
 - Double-click a single tag to switch between locked and unlocked.
4. Click **Save Config** to save and apply the current settings to the selected user account. The changes take effect the next time the user logs in to Cortex.

Note: The security tag "Screen: User Management" controls access to the **User Management** screen. By default, only the Administrator account can use the User Management screen.

Working with security tags

Locking some security tags lets administrators simplify the user interface for system operators. When logged-in, each user sees only the features and functions that are unlocked in that user's account on the User Management screen.

When a user account is selected on the User Management screen, the Security Tags box displays the account's security settings. Locked security tags have lock symbols; security tags without a lock are available to the user.

By default, the built-in Administrator account has access to all menus, screens and context buttons. Three other built-in accounts — Engineering, Maintenance, and Operator — are configured with some locked security tags. All security tags are locked when a new account is created on the User Management screen.

How security tags are organized

The Security Tags box displays a hierarchical list. "Menu" security tags are listed in alphabetical order. The "Menu" security tags correspond to the menu buttons in the [Navigation panel](#).

Individual screens are labeled "Screen" with the screen name. Context buttons on each screen are labeled "Button" with the button name.

Locking or unlocking a security tag for a menu button does the same for the associated screen buttons and context buttons. For example, unlocking the "Menu: Datalog" tag also unlocks the "Screen: View Data Log" tag, and the context buttons on the View Data Log screen. However, the reverse is not true: unlocking the security tag for a screen button does not change the security tag of the menu that is needed to access the screen. Screens cannot be accessed unless the security tags for both the menu and screen are unlocked. Therefore, be sure when unlocking a screen button that the associated menu button is also unlocked.



Example of limited menus based on user account settings.

Security settings for built-in user accounts

The following table shows the security tag configuration for the four built-in user accounts. A green circle indicates a security tag is unlocked; a lock indicates the security tag is locked by default. Security tags for Individual screen and command buttons are not shown in the table and may be locked, even though the associated menu is unlocked.

User Account				
Menu	Administrator	Engineering	Maintenance	Operator

Alarm				
Data Log				
Diagnostics				
Help				
Process				
Recipes				
Service				
System				
Handler				





















- 1) Debug Log screen is unlocked.
- 2) Tool Settings, User Log, and Exit screens are unlocked.
- 3) Manual Mode screen is locked.
- 4) Resource Usage screen is unlocked.
- 5) Transfer screen is unlocked.
- 6) Gas Unlock and Vacuum Unlock buttons are locked.

Recipe category security tags

There are "Read" and "Write" security tags for recipe categories. The security tags appear at the bottom of the list in the Security Tags box. Each tag is labeled "Recipes:" in red text.

The following table shows the locked and unlocked recipe categories for the built-in user accounts. A green LED identifies unlocked recipe categories (Read and Write access). A lock

indicates the recipe category is locked by default. The Personal category is linked to individual user accounts. Locking the Personal category makes in unavailable to the user account.

Recipe category	Built-in user account			
	Administrator	Engineering	Maintenance	Operator
Personal				
Engineering				
Experimental				
Production				
Archival				

1) Read access only.

Using Help in Cortex

Click the **Help** menu button to get information about Cortex. Click the **Help** screen button to display Help topics, or click **About this Release** to read brief notes about changes in each release of the Cortex software.

On the Help screen, the Contents, Index and Search tabs provide several ways to find information.

- **Contents** shows Help topics in sections, like the Table of Contents in a book. Click any title to display the Help topic.
- **Index** lists Cortex features and items alphabetically. You can type in the text box and press Enter to search the index. Matching topics are listed, and the first matching topic is displayed.
- **Search** finds any text in Help topics. Type a word or phrase in the text box and click **Search**. Topics that contain the search text are listed. Click a topic title to display the topic.

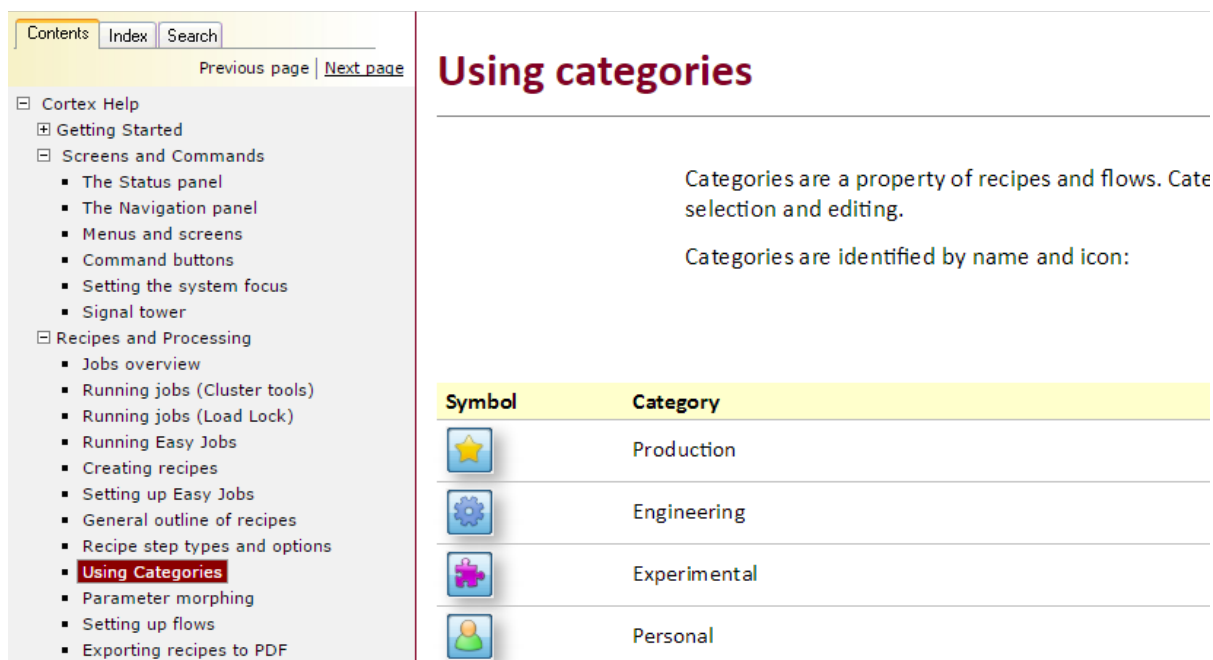

Contents | Index | Search





Previous page | Next page

- [-] Cortex Help
 - [+] Getting Started
 - [-] Screens and Commands
 - The Status panel
 - The Navigation panel
 - Menus and screens
 - Command buttons
 - Setting the system focus
 - Signal tower
 - [-] Recipes and Processing
 - Jobs overview
 - Running jobs (Cluster tools)
 - Running jobs (Load Lock)
 - Running Easy Jobs
 - Creating recipes
 - Setting up Easy Jobs
 - General outline of recipes
 - Recipe step types and options
 - **Using Categories**
 - Parameter morphing
 - Setting up flows
 - Exporting recipes to PDF

Using categories

Categories are a property of recipes and flows. Category selection and editing.

Categories are identified by name and icon:

Symbol	Category
	Production
	Engineering
	Experimental
	Personal

A topic selected on the Contents tab appears on the right.

Navigating in Help

Help topics are like Web pages. You can use hyperlinks to display other topics. When you point to a hyperlink, the pointer changes to a hand to indicate that the text is a hyperlink.

You can also use the following keyboard shortcuts and the tabs to navigate in the Help system:

- Going back:** Click **Go Back**, press ALT-Left Arrow, or Backspace to return to previous topics in sequence.
- Going forward:** After going back through topics, press ALT-Right Arrow to go forward through the topic history.

Saving and printing Help topics

Printing topics: Press CTRL+P to print the current Help topic. This requires an installed printer for the computer displaying the Help topic. Depending on the Version of Windows on the Corial system computer, you may be able to print to a physical printer, or save a copy of a topic as an Acrobat (PDF) file.

Selecting text: Drag the pointer over a section of text to highlight it, and then press CTRL+C to copy the selected text to the Clipboard.

Displaying Release Notes

Click the **Help** menu button and the **About this Release** button to display the Cortex release notes. All enhancements and resolved issues are listed, starting with the current version of the Cortex software.

Updating and using Help outside Cortex

Updating the Help system

All files for the Help system are stored in the "Help" folder in the Cortex program folder. To update the Help system if a new version is released, replace the entire Help folder with the updated Help folder.

Using Help outside Cortex

The Help system is self-contained, and can be displayed in a standard Web browser separately from Cortex. Copy the entire Help folder to another computer. To launch the Help system, double-click the file "hh_goto.htm."

System documentation

In addition to the Cortex documentation, each system includes a set of engineering drawings and other guides, all of which are described next.

Cortex documentation

Documentation for the Cortex control system is supplied as both a Help system that is available in the Cortex window, and a User's Guide that is supplied as an Acrobat (PDF) file. Printed copies of the User's Guide are available as an option.

The Cortex documentation covers all Cortex features, including the graphical interface, commands, and procedures such as the following:

- Creating and [editing recipes](#)
- Running [process jobs](#)
- Monitoring [gas channels](#), [vacuum train](#), and other subsystems
- Viewing process data with [charting](#), [job logs](#), and usage counters
- Performing maintenance tasks ([leak testing](#), [viewing logs and system data](#))

Other documentation

Other Corial system documentation is provided in digital form or optional hard copy. The system documentation includes the following:

- System manuals:** A set of manuals covering installation, quality control, maintenance, troubleshooting, and other aspects of the system is included with Cortex for Corial. The manuals are available by [clicking here](#), or by clicking "System Manuals" in the Contents tab of the Help screen.
- Additional software manuals:** If the system includes other Plasma-Therm software, such as GLANCE for data collection and analysis, EndpointWorks for endpoint detection, or the Factory Automation (SECS/GEM) Interface, these user's guides are available by [clicking here](#), or by clicking "System Manuals" on the Contents tab of the Help screen.

Cortex interface overview

Cortex provides powerful system-control features through an industry-standard, graphical user interface. The Cortex interface organizes information and controls to simplify navigation, reduce errors, and increase productivity.

Main parts of the Cortex interface

The main parts of the Cortex interface are labeled in the following illustration.

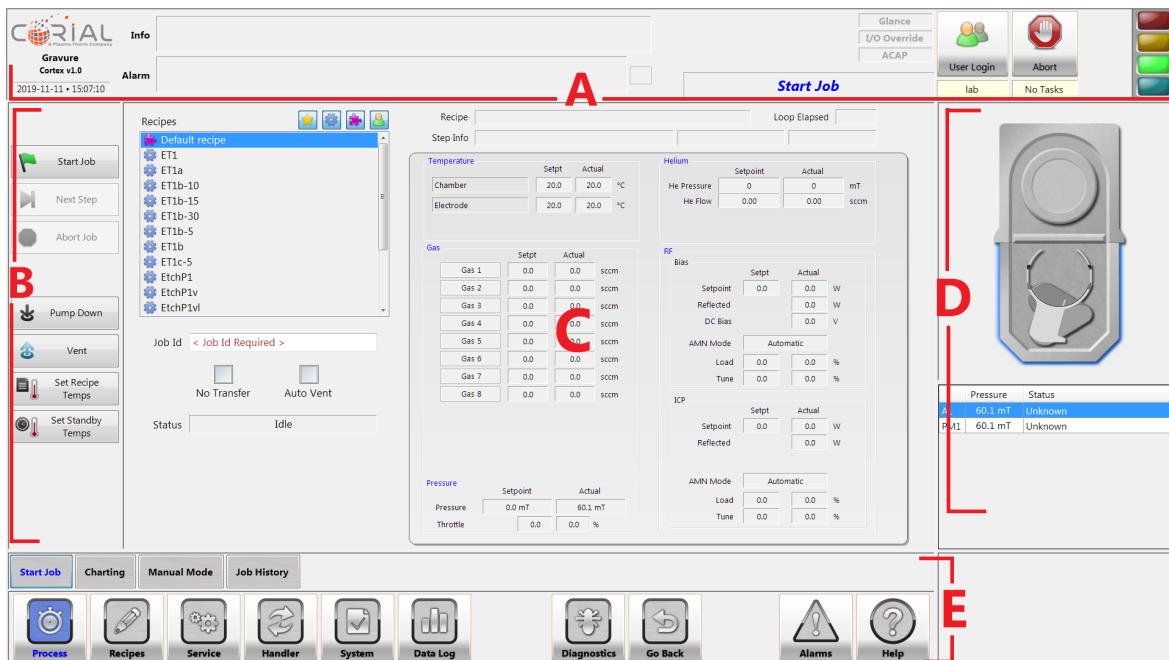

A) Status bar: This panel at the top of the screen displays status information. The date, time, and software version are at the left. The **Login** and **Abort** buttons and light tower are at the right. The Alarm and Info boxes, and indicators for Glance and I/O overrides are in the center of the panel.

B) Context buttons: Buttons on the left perform actions, such as Start Job and Pump Down. These buttons change when the main panel changes.

C) Main panel: The functions of the main panel and command buttons are determined by the chosen menu and screen buttons. When Start Job (shown above) is selected, the main panel lists the available recipes, and shows process setpoints and actual values during processing, for example.

D) System overview: A graphic representing the system appears on the right of the screen. Below the graphic, Cortex displays the current pressure and status, such as "Processing" or "Idle." The color of the viewport indicates whether the system is idle (black), processing (red), or vented (light blue).

E) Navigation panel with menu and screen buttons: The [Navigation panel](#) at the bottom of the screen contains [Menu](#) buttons and Screen buttons. These buttons control the contents of the main panel.

Indicator colors for material and parameters

Throughout Cortex, color shading indicates the status of process parameters, valves, pumps, and other components.

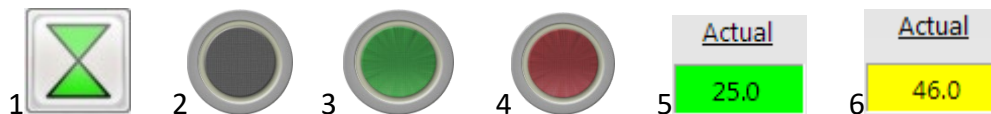

Status indicators: (1) Open valve. (2) Unprocessed wafer. (3) Processed wafer. (4) Bad wafer (process interrupted). (5) Process parameter in compliance. (6) Process parameter not in compliance.

- Green:** Active items whose values are within their tolerance range. For example, gas flow values are highlighted in green when the flow is within tolerance. Green also indicates processed material, and valves in the open position.
- Yellow:** Active items whose values are not within the setpoint tolerance. Yellow also is used for warning alarms.
- Gray:** Inactive systems and components, including closed valves. Command buttons that are unavailable are also shaded gray.
- Red:** Error conditions, alarms, and material that was not processed successfully.

Standards of the interface

Cortex is similar to other program that run in Microsoft Windows. Cortex uses many standard controls, including text boxes, drop-down lists, arrow buttons, check boxes, and so on.

As with other Windows programs, you can use common shortcuts and ways of interacting with Cortex. These include using TAB and adjusting values, as described under "Using shortcuts" below.

However, Cortex differs from common Windows programs in several ways:

- Cortex fills the screen, and the program is not meant to be moved, closed, or resized.

- Cortex does not have a traditional title bar, Close box, Minimize/Maximize buttons, or a toolbar.
- Cortex does not have traditional menus. Instead, menu buttons are at the bottom of the screen. This complies with the SEMI standard (SEMI E-95-1101) for user interfaces.
- Users can see differences in Cortex, because user [account settings](#) can hide features. This can include menus, screens, buttons, and recipe categories.

Viewing tooltips



Cortex provides **tooltips** to identify controls and system components when the pointer is on them.

On the [Gas System](#) and [Vacuum System](#) screens, tooltips identify valves that can be toggled by clicking them: "Toggle Iso Valve" and "Toggle Rough Valve," for example.

Using shortcuts

You can use standard Windows shortcuts for selecting items and changing values:

TAB to move: Press the TAB key to move to and select the next value or setting, such as Setpoint values on the Edit Recipe and Manual Mode screens.

Hold down SHIFT and press TAB to move in reverse.

<u>Gas Name</u>	<u>Setpoint</u>
Gas1	30.0
Gas2	30.0
Gas3	0.0
Gas4	0.0
Gas5	0.0
Gas6	0.0

Arrows indicate TAB sequence through gas Setpoint boxes.

Toggle items: You can move among items and toggle them (turn on and off) using the keyboard. Pressing TAB moves the focus among items, such as valves on the Vacuum System screen. The item that has focus is outlined in blue. Pressing SPACEBAR toggles the item that has focus.

Adjusting values: There are several ways to change numeric values and other settings. Click on a value and then do the following:

- Press the keyboard Up Arrow and Down Arrow keys to increase or decrease numeric values.
- Click the small arrow buttons to increase or decrease numeric values.

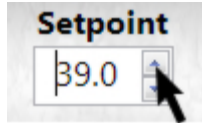

- Select a numeric value or text item and type a new value or text.

You can also use the keyboard arrow keys to move through drop-down lists and menus, such as the Category list on the Edit Recipe screen, and the material list on the Start Job screen.

Signal tower status indicators

Cortex displays an on-screen representation of the tool's signal tower. The signal tower graphic is always displayed at the right end of the Status bar at the top of the screen.







The lights in the signal tower graphic show the status of the tool in the same way that the tool's physical signal tower does. If the yellow light is blinking, for example, the system has an active warning condition.

When the system is idle, if there are no alarms or warnings, and the lock has not been vented, only the green light is on (not blinking), as in the illustration at left.

The Info and Alarm boxes in the Status bar provide messages describing tool operation, events, and alarm conditions.

The next table shows signal tower lights and describes the meaning of their appearance. The images shown are when the lights are "on."

Light	Color	On	Blinking
	Red	[Not used]	One or more alarms are active
	Yellow	[Not used]	One or more warnings are active
	Green	System is idle	System is processing
	Blue	Module is vented	Module is venting

The Status bar

The Status bar displays important information on all Cortex screens. It contains the Log In and Abort buttons, and several types of status indicators. The screen name, such as "Start Job," appears in blue type in the Status bar.

The following sections describe each item in the status bar. Some items, such as factory automation indicators, do not appear unless they are configured on the system.

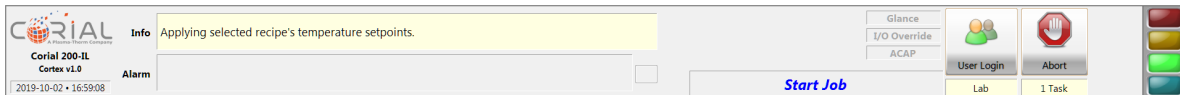

The Status bar includes the screen name, status and alarm messages, and other controls.

Tool and software information



The left end of the Status bar displays the following information under the Corial logo:

- Tool name. This is typically the Corial model name or a tool ID number. This is entered on the System Configuration screen.
- Cortex software version.
- The current system date and time from the system computer's Windows clock.

Tip: To show the software build numbers for Cortex, hover the mouse over the Cortex version number. Build numbers for Cortex Core and Cortex Corial will appear. These give the exact control system software version.

System messages and alerts (alarms and warnings)

Info box

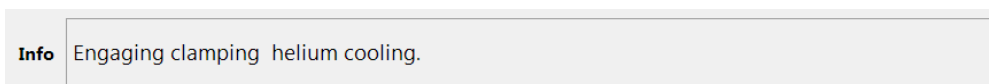

The Info box displays system activity and status messages, such as "Processing" when a job is running, "Pumping down lock" when pumping starts, and "Manual Mode: Turning on x subsystem" when a subsystem is activated on the Manual Mode screen. When a recipe or settings (tool settings, user accounts, and others) are saved, a confirmation message appears in the Info box.

All of the messages are recorded in the file "Info Log.txt" in the Cortex Diagnostics folder. The messages that appear in the Info box are removed automatically after about 5 seconds.

Alarm box



The Alarm box displays messages about all alerts (alarms and warnings). The number of alarms and warnings appears in a small box to the right.

Messages scroll continuously if the message text does not fit in the box.

Cortex posts two kinds of alerts: Red (alarms) and Yellow (warnings). The background color indicates the alert type. See [Identifying and resolving alarms](#) for details about alerts and how to resolve them.

Shortcut: Click the Alarm box to go to the **Active Alarms** screen. The screen displays all active alerts and the available resolution options.

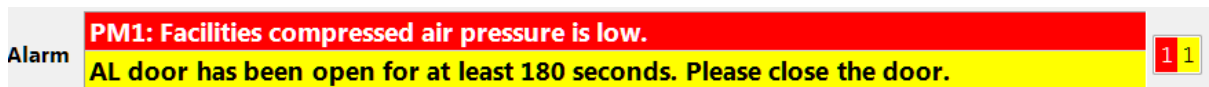

Red and yellow alerts in the Alarm box.

User Login and current user

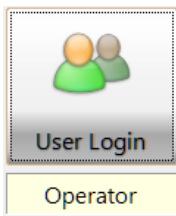

Just below the User Login button, a box displays the name of the current user — the [user account](#) that is logged in to Cortex. If no user has logged in, the box displays "Nobody."

Clicking the **User Login** button opens a dialog box. In the dialog box, users can [log in](#), [log out](#), and [change the logged-in user](#).

It is important to know that the Cortex interface can be different for different users. This includes which [menu buttons](#) and [screen buttons](#) are displayed, and which commands are available. These differences are based on the [security settings](#) of the current user.

Abort button and task list



The **Abort** button can be used to review all tasks being carried out by the system, and to interrupt active tasks.

The box below the Abort button displays the number of tasks the system is actively performing.

Clicking **Abort** displays the Active Task List (unless there are no active tasks). The Active Task List is a dialog box that lists all active tasks, with the total elapsed time for each task. Clicking a task in the list selects it, and clicking **Abort Task** tells the system to end the selected task.

Click **Exit** to close the Active Task List dialog box.

Alarms and options for aborted tasks

When tasks are aborted, Cortex may post one or more alerts. An operator might have to [choose a resolution option](#) on the Active Alarms screen. For example, if a process job is aborted, Cortex may post an alert that processing has been interrupted. The Active Alarms screen will typically list options for terminating the job, including leaving or removing material. If there are no other options, an "Acknowledge" button appears on the Active Alarms screen. Click **Acknowledge** to clear the alarm.

Signal tower



The far right of the Status bar displays a signal tower, which operates the same as the signal tower installed on the tool. The indicator "lights" on screen can be on, off, or blinking.

The signal tower lights show the tool's [operating status](#) at all times.

Other status indicators

Labels in the Status bar light up to indicate "active" status for [GLANCE](#), [I/O signal overrides](#), and [ACAP activity](#). The labels are to the left of the **User Login** button.

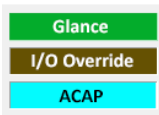

ACAP activity

The Auto Clean and Prep (ACAP) feature can be used with operator assistance to automatically run cleaning recipes and chamber prep recipes. The "ACAP" label in the Status bar is bright blue when an ACAP action is activated.

Glance communication status

The "Glance" label is green when Plasma-Therm's Glance program is active and is linked to Cortex to collect data. Glance provides functions for analyzing process data, and it communicates with Cortex when both programs are active.

I/O override indicator

The "I/O Override" label is highlighted when one or more signal overrides is active. Overrides of I/O signals are controlled on the Service menu [I/O screen](#). When the pointer is on the I/O Override label, a tooltip lists the module ("PM1" for example) where the override is active.

Factory automation icons

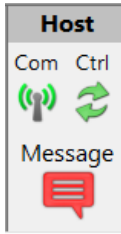

If the optional [factory automation \(SECS/GEM\) interface](#) is configured in Cortex and is active, two icons appear in the Status Bar. These icons show by their color whether communication with an automation host is taking place. In addition, an alert icon appears if a message is received from the host. These icons do not appear if the factory automation feature is not configured and activated, and the license key is installed in the system.

Note: The factory automation interface is not active in version 1.0 of Cortex on Corial systems.

Navigating to menus and screens

The *Navigation panel* is at the bottom of the Cortex window. It contains *menu buttons* and *screen buttons*, which are used to navigate to all Cortex features.

Menu buttons are square, with icons and text labels. Screen buttons are smaller rectangles, and text labels. At any time, one menu button and one screen button are selected. The selected buttons have blue text and icons.



Screen buttons (top row) and menu buttons in the Navigation panel. The Process menu and Start Job screen are selected.

Selecting menus and screens

To select a menu button, click it. This displays the menu's screen buttons. For example, if you select the Process button, these screen buttons appear: Start Job, Charting, Manual Mode, Job History (see previous illustration). See the [Menus and screens topic](#) for a complete list of Cortex menus and screens.

Whenever you select a menu button, the last selected screen button also is selected. Therefore, you do not always need to select a screen button after selecting a menu button.

Displaying previous screens

Click **Go Back** in the Navigation panel to return to previously displayed screens in sequence. On touchscreen-equipped systems, you can also "swipe" to the right to go back, or to the left to go forward, through the sequence of previously displayed screens.

The Go Back button is the only one in the Navigation panel that does not remain selected when you click it. Each time you click **Go Back**, Cortex displays the preceding screen in sequence, back to the last time Cortex was started.

About Cortex screens

We refer to various "screens" in Cortex, such as the Start Job screen. In fact, only the central area (*main panel*) of the Cortex window and the *context buttons* on the left are different on different "screens." The other areas of the screen contain standard components that are common among all screens; see the [Interface topic](#) for more information.

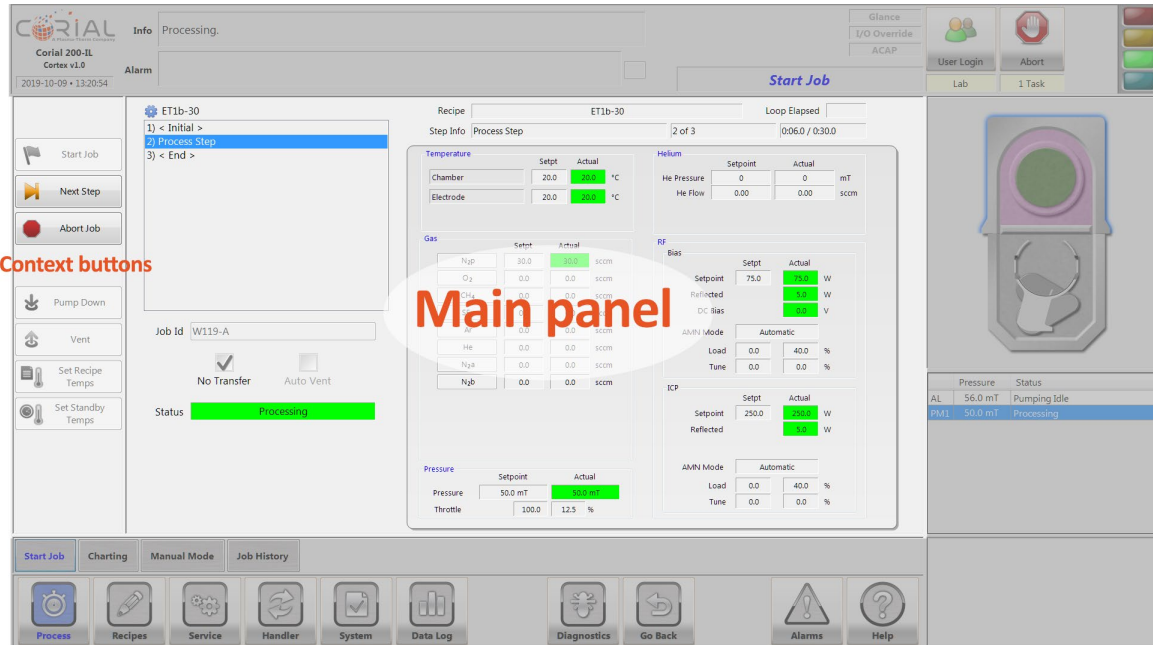

Selecting a screen button changes the main panel and context buttons. The shaded areas are standard panels.

Availability of menus and screens

A user's ability to access menus and screens is determined by the user's account [security settings](#). When a user does not have access to a menu because its security tag is locked in the user's account settings, that menu button does not appear in the Navigation panel. Most system operators will not see all the Cortex menu and screen buttons.

For example, the built-in Operator account limits the user interface to essential functions, as shown in the following illustration.

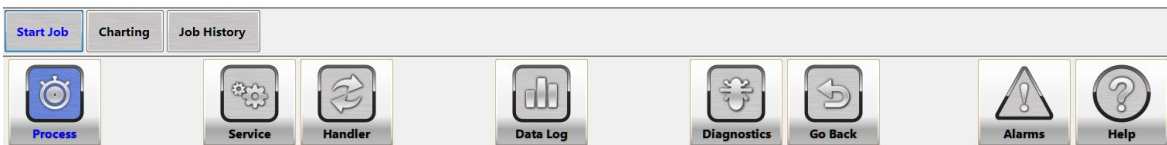









A limited set of menus and screen buttons appear when the Operator account is logged in.

Menus and screen functions

Cortex for Corial systems organizes features and controls in *menus* and *screens*. Both are represented by buttons in the [Navigation panel](#) along the bottom of the Cortex window.

The following table lists the Cortex menus in alphabetical order. For each menu, the associated screens are listed. See the note section following the table for information about hidden buttons.

Menu	Menu button	Screens	Functions
Alarms		Active Alarms	Review active alarms, silence audible alarm, choose alarm resolution options.
		Alarm History	Show previous alarms, filter listing by date and keywords.
Data Log		View Datalog	Plot process parameter data from process log files.
Diagnostics		Debug Log Variables Managers Task Log Sequencer View Events	Show internal status and troubleshooting information. This menu is hidden from most users by default.
Handler		Transfer	Manually transfer material between chamber and load lock.
		Teach	Configure robot transfer arm.
		Cycle Test	Run continuous material transfers or arm movement cycles, display previous cycle test results.

Help		Help	Display Help topics, search for information by keyword.
		About this Release	Display release notes for Cortex software versions.
Process		Start Job	Run process jobs using saved recipes.
		Charting	Plot process parameter data during processing.
		Manual Mode	Apply settings for temperature, pressure, gas, and RF power without using a saved recipe.
		Job History	Display data about completed jobs and processed material.
		Interactive	Run recipes with the ability to adjust parameters, and save changes.
Recipes		Edit Recipe	Create, save, load, and edit process recipes.
		Clean & Prep	Set up automatic processes with rules and triggers.
Service		Gas System	View status, and manually operate gas system components.
		Vacuum System	View status and operate components of the vacuum system.
		Mechanism	Monitor and control the cathode lift and the chuck cooling circuit.

	I/O	Monitor control signals with the ability to plot and override values.
	Leak Test	Test chamber and gas lines and review past test results.
	Gas Maint	Evacuate or flush selected gas lines for maintenance.
	Usage	View and reset counters for gas usage, RF on-time, and wafer count.
	Module Mode	Enable or disable process chamber.
	Configuration	Apply settings and options for system components.
	Tool Settings	Review and adjust settings for endpoint, gas flow, logging, maintenance, processing, RF generators, vacuum, and the Cortex interface.
System		User Management
		Manage user accounts, and control access to menus, screens and commands.
		User Log
		Review records of users logging in and out from Cortex.
		Exit
		Shut down the Cortex control program.

Available functions for individual users

The available menu and screen buttons can vary. The [security settings](#) for the logged in [user account](#) determine which buttons are displayed. By default, some buttons are hidden for most users; only the Administrator account has access to certain menus and screens.

Applying commands with Context buttons

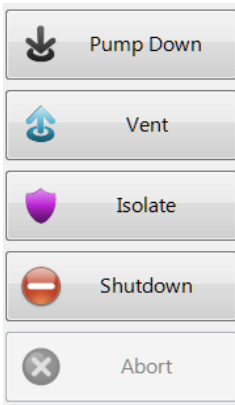

Context buttons on Vacuum System screen.

At most times, buttons appear in the left panel of the Cortex screen. These *context* buttons perform commands that depend on the screen context — the functions and devices that are contained in the screen's main panel.

For example, the **Save** button in the Recipe Editor saves the current recipe. On the Clean & Prep screen, the **Save** button saves the current set of ACAP rules. On the Teach screen, **Save** stores the current device settings, such as the transfer arm settings, from the main panel.

Context button indicators

The color of context buttons shows whether they are available:

- Most context buttons have a color icon, and are highlighted in blue when the pointer is on them. This indicates their actions can be applied in the current context.
- A context button that is gray is "not available." Buttons are not available if their actions cannot be performed because of the current state or activity of the system. For example, the **Start Job** button is not available if a job is already running, and the **Abort** button is not available if there is no current activity that can be aborted.



Start Job button: highlighted (left), not available (right).

Creating process recipes

The Recipe Editor for creating and editing process recipes. You can also export recipes and archive recipes from the Recipe Editor screen.

The next section provides a general procedure for creating recipes. Later sections describe advanced settings and alternative recipe views.

The Recipe Editor always contains the last recipe that was edited. When Cortex is restarted, the Recipe Editor contains a default new recipe, with four default steps.

To create a new recipe

1. Click **Recipes > Edit Recipe**. The Recipe Editor appears.
2. Click **New Recipe**. A message asks whether to save the existing recipe if one was loaded.
3. Enter information to identify the recipe:
 - Type an identifying name in the *Recipe Name* box. Recipes are listed by name on the *Start Job* and other screens. You cannot save a new recipe without changing the default name. Recipe names can contain letters, numbers, and special characters.
 - Type a description (optional) to help identify the recipe. The description is optional.
 - The *Category* box shows the current category. Click the box to select another [category](#) for the recipe. The category can limit who can use or edit a recipe. [User account settings](#) control access to each category. A user can always access recipes he or she creates; these are automatically included in the Personal category.
4. The Initial step is selected by default. The step's parameters are on the *Initial Parameters* tab. Enter the *Hold Time*, *Base Pressure*, and *Temperature* setpoints for the step. See [Recipe step types and settings](#).
5. Select any other default steps and enter the required parameters. All recipes have a Stabilization step. Some may have other default steps, depending on the type of process module.
6. To insert additional steps, press "Insert Step" button's arrow and choose the step type. If you click the button, a Process step is inserted. Enter setpoints and select options on the *Process Parameters* tab for each inserted step.
7. Click **Save** to save the recipe. The recipe remains in the Recipe Editor. Steps can be inserted, deleted, and parameters can continue to be modified. If changes are made after a recipe is saved, "**< Modified >**" appears next to the Category box. Click **Save** to store the changes, or click **Revert** to discard all changes made after the recipe was last saved.

Copying recipes

After saving a recipe, you can copy it by typing a different name in the Recipe Name box, and then clicking **Save**. This creates a recipe with identical steps and parameters, but with the new name.

The Recipe Editor always contains the last recipe that was edited. When Cortex is restarted, the Recipe Editor contains a default new recipe, with the four default steps listed in the Steps box.

Changing the recipe category

If a recipe has been saved, and you change the category and click **Save**, a message asks what to do. Click one of the following buttons to save the recipe and either keep the original or discard it:

- **Remove [original category] version:** Saves the recipe with the new category you selected, and discards the original recipe.
- **Keep Both:** Creates a copy of the original recipe that is assigned to the new category.

Interactive recipe development

The *Interactive screen* is a powerful tool for recipe development and refinement. A saved recipe can be adjusted while it is being executed on the Interactive screen. Both the timing of process steps, and the setpoints for recipe parameters, can be changed while the recipe is running. The screen also includes a chart for plotting parameter values.

To run a recipe on the Interactive screen, the recipe must first be saved using the regular recipe creation procedure, as described above.

Viewing recipes in tabular form

To see all of a recipe's steps and setpoints at once, click the **Tabular View** tab on the Recipe Editor screen. The tabular view can be used at any time when creating and editing recipes. Tabular view lets users enter setpoints for process parameters, and set the duration of steps.

	1. < Initial >	2. < Chuck >	3. Process Step	4. Process Step	5. Loop 3 times	6. < Dechuck >	7. < End >
Time	0:10.0	0:30.0	1:00.0	1:30.0		0:30.0	1:30.0
Pressure	10	10	5	5		10	10
SF6		0	30	0		0	
C4F8		0	0	25		0	
O2		0	0	0		0	
N2		0	0	0		0	
He		3	0	0		3	
NH3		0	0	0		0	
Ar		0	0	0		25	
Bias		50	50	50		0	
ICP		100	150	150		0	

A recipe in Tabular View. The first cell is selected.

Values displayed in tabular view

Tabular View displays the current recipe's steps and setpoints in rows and columns:

- The column headings are the step numbers and names. The Initial step is on the left and the End step is at the right.
- Each row shows a specific process parameter (Time, Pressure, gas channel, RF) for all recipe steps.
- Cells shaded dark gray are not available. This includes gas flow in the Initial and End steps.
- If steps and parameters do not fit in the window, scroll bars appear so the table can be scrolled up-down and left-right.

Highlighting of setpoint changes

The Tabular View highlights changing parameter values. In each row, adjacent values that differ are shaded light orange. To turn shading on or off, right-click at the top of the table and choose **Show Differences**. A check mark indicates that shading is enabled.

Pressure	10	10.0	5.0	5.0
----------	----	------	-----	-----

Shading highlights a Pressure setting change from one step to the next.

Editing in tabular view

To change parameters in the table, click to select a value and type a new value. The selected table cell is highlighted. You can press TAB or the keyboard arrow keys to move the selection. When you finish changing values, click **Save** to store the edited recipe.

Adding and deleting steps

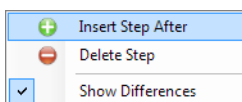

Right-click a column heading at the top of the table to insert or delete a step.

Add a step: Choose **Insert Step After** to add a new step to the right of the column heading where you clicked.

Delete a step: Choose **Delete Step** to delete the column that you clicked. You cannot delete Initial or End steps.

While recipe steps can be inserted and deleted in tabular view, step names and descriptions can be changed only on the Process Parameters tab.

Adjusting tolerance, ramping, and morphing

The Details tab in the Recipe Editor contains specialized settings for process steps. These include tolerance, ramping, and morphing.

When a Process step is selected in the Steps box, each parameter's **tolerance** and **ramp settings** can be adjusted. If the Process step is in a loop sequence, morphing can be applied to parameters. **Morphing** can adjust process parameters gradually across iterations of a loop sequence.

For more information about Process steps, see [Step types and settings](#).

	Start Setpoint	End Setpoint	Morph	Tolerance	Unit	Ramp Delay (ms)	Ramp Time (ms)
▶ Time	300.0	300.0	1.0		s		
Pressure	30.0	4.0	1.0	5.0	mTorr	0	0
Gas 1	30.0	30.0	1.0	2.0	sccm	0	0
Gas 2	45.0	45.0	1.0	2.0	sccm	1,000	2,000
Bias	125	125	1.0	10	W	0	0
ICP	300	300	1.0	10	W	0	0

The Details tab contains Morph, Tolerance, and Ramp settings.

Using recipe categories

Categories can be used to organize and control access to recipes. Categories can be identified by icon or name:

Recipe categories

Icon	Name
------	------



Production



Engineering



Experimental



Personal



Archived

Assigning recipes to categories

Every recipe is assigned to a category. When you are creating or editing a recipe on the [Edit Recipe](#) screen, click the Category box to select a category. The categories that are available can be limited by the following:

- Only the categories the logged-in user has "write" access for are listed.
- The Archived category is not available when creating or editing recipes. Recipes can be archived by using the **Archive** button in the Recipe Editor.

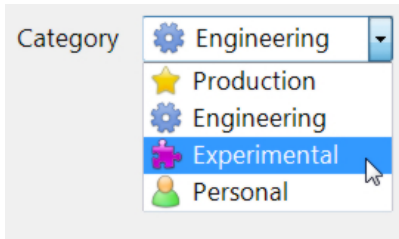

Selecting a category for a recipe.

Changing a recipe's category

If you load a recipe and change only its category, when you click **Save**, Cortex asks whether to copy or change the recipe. Do one of the following:

- Choose **Remove [category] version** to change the recipe to the new category.
- Choose **Keep Both** to save a new version of the recipe with the new category, and keep the original version with its original category.

Using the standard and Personal recipe categories

Recipe categories are arbitrary; there are no differences in process recipes based on category. The category determines only if a recipe is displayed in the Recipes list for the logged-in user. In other words, a user sees recipes only in categories that are unlocked for “Read” access in the user's account. See “Controlling user access to categories,” below, for information about Read and Write access for recipe categories. See the section “Filtering the Recipes list by category” for information about showing and hiding categories.

The Personal category is unique to each user account. When a user creates or edits a recipe, it can be assigned to the Personal category. Users can see only their own Personal recipes. No user can see another user's Personal recipes.

Filtering the Recipes list by category

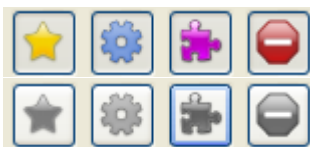

Selected categories (top)

unselected categories (bottom)

Category buttons are above the Recipes list on the Start Job screen and in the Load Recipes dialog box. Use the buttons to show or hide recipes by category.

Selected category buttons are in color. All recipes in the selected categories are shown in the Recipes list.

Unselected category buttons are gray. Recipes in unselected categories do not appear in the Recipes list.

If the logged-in user does not have access to a category (described next), the category button is hidden.

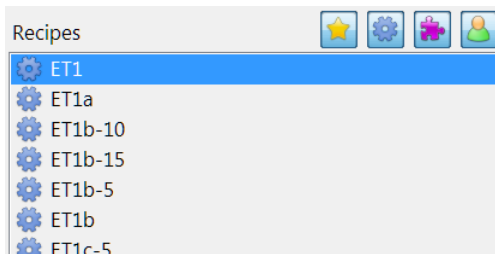





Category buttons above the Recipes list

Controlling user access to categories

Categories can be used to limit "read" access to recipes, or "write" access, or both. Read access lets the user select recipes in the category. Write access allows the user to assign recipes to the category.

Access is granted by unlocked [security tags](#) for recipe categories. By default, the built-in user accounts have limited access, as shown in the table below. Note that each user has Read and Write access to their own Personal category.

In the Security Tags box on the [User Management](#) screen, the tags that control access to each category are labeled "Recipes:" followed by the category name and "Read" or "Write." These tags are at the end of the list, below the "Menu: System" tags.

-  Recipes: Archival
-  Recipes: Engineering - Read
-  Recipes: Engineering - Write
-  Recipes: Experimental - Read
-  Recipes: Experimental - Write
- Recipes: Personal
- Recipes: Production - Read
- Recipes: Production - Write

Recipe security tags: Production and Personal categories unlocked.

To grant access to a category

1. Click System > User Management to go to the User Management screen
2. In the Users box, select the account to change.
3. Select the security tags for the category. Select both the Read and Write tags to grant full access.
4. Click **Unlock**.
5. Click **Save Config**. The new settings take effect immediately.

To deny access to a category

Follow the procedure above, but click the **Lock** button in Step 4.

Default settings for recipe categories

User account	Tag	Unlocked categories
Administrator	Read Write	All ¹
Engineering	Read Write	All ¹
Maintenance	Read Write	Production, Personal ¹ , Archival
Operator	Read	Production, Personal ¹

¹ No user account has access to another user's Personal category.

Overview of process recipes

Process recipes consist of a series of steps. When you create a recipe, default steps are included, and you can insert additional steps.

There are several types of recipe steps in Cortex, including Process, Temperature, and Flush steps. The following sections describe each step type and how they provide the required functions for process recipes.

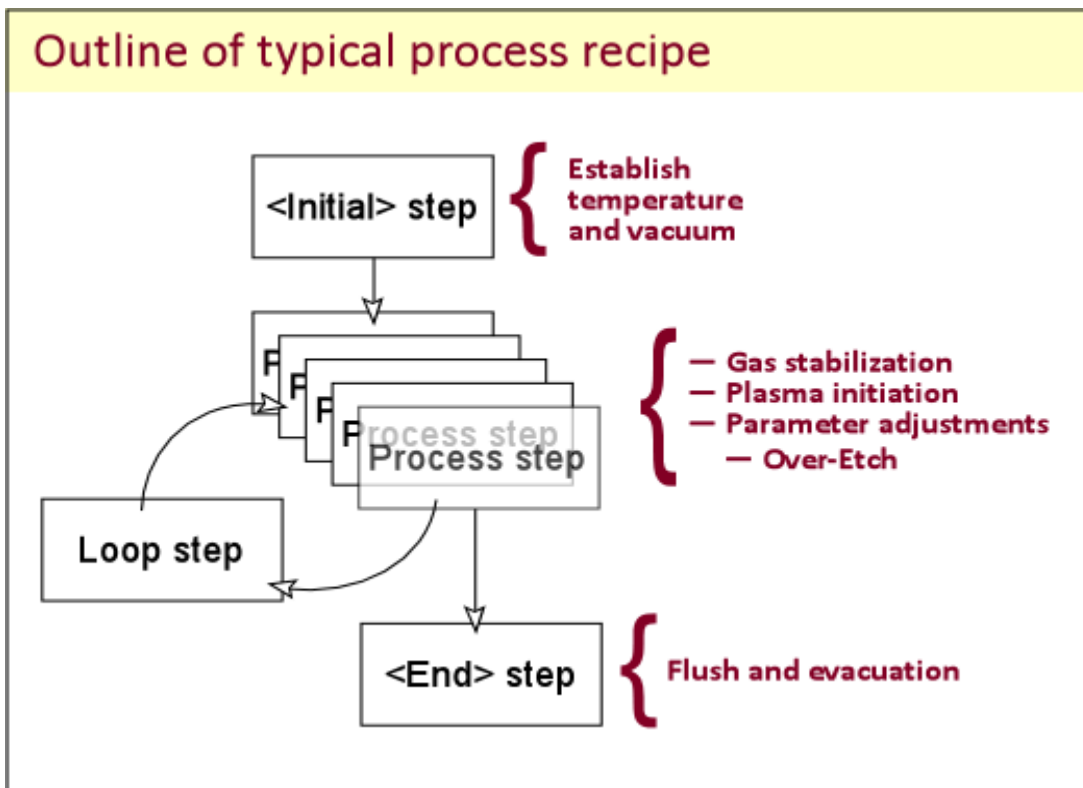

Diagram of a typical process recipe, with step types and their functions.

1. Establishing initial conditions

The chamber pressure and temperature are established before processing begins in the Initial recipe step. The step's length (Hold Time setting) is counted from when pressure and temperature are in compliance; it should be long enough to allow chamber conditions to stabilize. The Initial step is the required first step in all recipes. Temperature changes during processing can be applied with additional Temperature steps, which can be placed anywhere in recipes after the Chuck step and before the Dechunk step.

2. Applying chuck settings

Helium backside cooling is initiated and stabilized in the Chuck step. Gas flow and RF power can also be applied in the Chuck step. The Chuck step is a required step that follows the Initial step in all recipes (on ICP systems). System with no clamping or backside cooling do not require a chuck step. A Dechuck step at the end of processing can apply new setpoints for pressure, gas flow, and RF power.

3. Stabilizing gas flow

In Process steps, one or more gas flows are initiated and maintained at a specified rate.

4. Initiating ('lighting') plasma

Once pressure, temperature, and gas flow are stabilized, RF power is applied to create a plasma. This is typically a separate Process step. Each process step can apply setpoints for pressure, gas flow, RF power and match network. Each process step can also use a different termination method, including an endpoint signal from EndpointWorks.

5. Main processing sequence

Additional Process steps can be added to perform particular etching functions and etch/deposition sequences, using loop sequences. Each process step can change setpoints for RF power, pressure, and gas flow, and change match network settings.

Applying additional etching time

Depending on the amount of over-etch specified in a recipe, gas flow and RF power may be adjusted in one or more final Process steps to achieve specific results. A process step can have Over-Etch as the step "End By" parameter. The duration can be a percentage of the previous step's actual duration, or a fixed time.

6. Flushing gas lines

The system's gas lines can be flushed individually for a specified time in a Flush step, which are optional in recipes.

7. Final pumping

After main processing is complete, the process chamber can be pumped down to base pressure and held for a specified time in the End step of a recipe. The End step is required as the last step in all recipes.

Recipe step types and settings

A process recipe consists of a series of *steps*. Several types of steps are available. Several step types are required in all recipes, while others are optional.

The description of recipe steps begins with an overview of the various step types, followed by sections on specific types and their settings.

Overview of step types

The following table lists the step types that can be used in Corial recipes, with brief descriptions of their basic functions.

Step type	Function	Notes
Initial	Establish pressure and temperature before processing begins.	First step in all recipes.
End	Hold specified pressure after processing.	Last step in all recipes.
Process	Primary process step. Specifies pressure, gas flow, RF power.	Special settings include Ramping of parameter changes.
Loop	Define a series of steps (<i>a loop sequence</i>) to be repeated	" Morphing " can modify process parameters across loop iterations.
Evacuation	Pump down chamber to base pressure.	Pumps down to base pressure
Temperature	Change temperature during processing.	Separate setpoints for temperature channels.

Selecting step types in the Recipe Editor

The step type is specified by selecting from the **Insert Step Before/After** button in the Recipe Editor. Press the arrow button to display the list. The available step types depend on the step that is selected in the Steps box. For example, a Loop step cannot be selected unless a Process step in the recipe is currently selected.

You can insert a Process step by clicking the button without opening the drop-down list.

See [Creating Recipes](#) for basic information about the Recipe Editor and settings that apply to all recipes.

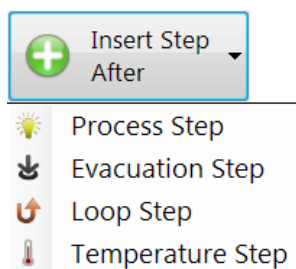

The Insert Step button and the drop-down list of step types.

Initial step settings

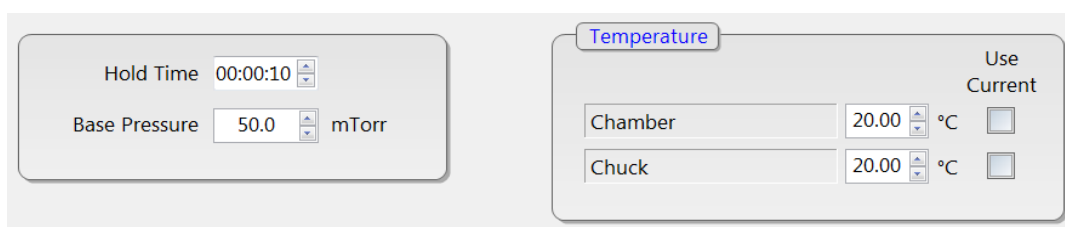

Settings for Initial steps on the Initial Parameters tab.

The first step in every recipe is labeled < Initial > in the Recipe Editor. This step establishes pre-processing base pressure and temperature, which can be changed in later steps.

At the beginning of the Initial step, Cortex opens the purge gas channels (if any are configured) and purges the gas manifold. The system then pumps below the specified pressure for the duration specified by the step's "Hold Time" value.

Pressure and hold time

Hold Time: The length of time to hold at or below Base Pressure. Specific the duration as *hours : minutes : seconds*.

Base Pressure: The pressure to pump below for the specified Hold Time. Enter the pressure in scientific notation, such as 5.0×10^{-3} for 5 mTorr (using the system's configured pressure unit — Torr, bar, or Pascal).

The Stabilization Timeout [Tool setting](#) determines how long the system waits for compliance during the Initial step.

The Stabilization Timeout also applies to Temperature steps when "Wait for Compliance" is selected. Otherwise, the Process Timeout tool setting is used.

End step settings

The final step of every recipe is labeled < End > in the Recipe Editor. The End step is inserted by automatically and can't be deleted.

During the End step, the system holds the at or below the specified pressure for the amount of "Hold Time" for the step.

For the End step, enter the following values:

- Hold Time:** The length of time to hold the chamber at or below the Base Pressure. Specify the duration as *hours : minutes : seconds*.
- Base Pressure:** The pressure for the chamber to be at or below, for the duration specified by the Hold Time setting.

The Hold Time and Base Pressure values can be entered on the End Parameters tab or the Tabular View tab in the Recipe Editor.

Process step settings

Process steps implement gas flow, RF power, and pressure. Process steps also have duration settings, and options for handling process interruptions.

This section describes Process step setpoints. See "[Parameter morphing](#)" for how to adjust parameters in loop sequences. See "[Setting the length of Process Steps](#)" for options to control the duration of Process steps. See [Process parameters, options and settings in recipes](#) for a complete list of settings in table form.

In the Recipe Editor, three tabs contain settings and editing views for Process steps:

Process Parameters: This tab contains the setpoints for pressure, gas flow, and RF power, and the step termination setting.

Details: This tab displays setpoints in a table that includes tolerance, ramping, and morphing settings.

Tabular View: This tab displays an editable overview of the current recipe.

Process Parameters | Details | Tabular View

Step Name: Process Step | Description: First etch step | Restart Step

Step Termination

End By: Endpoint Detect

Max Time: 10 min : 0.0 s

EP Recipe: abc.epr

On EP Not Found: Warning

Min EP Time: 3 min : 0.0 s

Gas (sccm)

O2	45.0	sccm
C2F6	0.0	sccm
Ar	5.0	sccm
N2	5.0	sccm
CH4	0.0	sccm

Pressure

Pressure: 100.0 mTorr

RF

Setpoint: 250 W

Gas flow, pressure, and RF power setpoints are on the Process Parameters tab.

Setting gas flow

Specify gas flow for any available gas channels by entering the flow value in standard cubic centimeters per minute (SCCM).

Setting RF power

In the setpoint boxes, enter the RF power in Watts for the RF generator(s). The maximum setpoints are controlled by the system configuration settings.

The AMN mode can be selected from the menu. The default mode is Automatic. If the mode is set to Man->Auto or Manual, specify the Load and Tune positions to use. The time delay in switching from manual to automatic operation is controlled by the tool setting "Match Box Switch Delay."

Setting chamber pressure

Enter the pressure to maintain during the Process step, using the system's configured pressure unit — mTorr, mbar, or Pascal.

Designating 'Restart' steps

3) Process Step 

In the Steps box, a circular arrow at the right of a Step's name signifies a Restart step. This designates to run when processing restarts being interrupted. Non-Restart steps are skipped when processing is restarted.



On the Process Parameters tab, click the **Restart Step** toggle button to designate the current process step as a restart step. Deselect the button to un-designate the Process step as a restart step.

Once you click **Restart Step**, it remains selected, and subsequently inserted Process Steps are designated as restart steps. Inserting a non-process step de-selects the Restart Step button.

Note: If "restart processing" is selected on the Alarms screen, Cortex runs the Initial step before running the designated restart steps. However, if a "continue" recovery option is selected, processing starts at the current Process step, not the Initial step.

Setting Chamber Mode

A process step can be set to one of two settings in the Chamber Mode box:

Deposit Mode: This is the default mode for process steps.

Clean Mode: When this setting is selected, enter the pressure to maintain the reactor (process chamber) in the Reactor Pressure box.

Options for the duration of Process steps

The duration of a Process step can be pre-set, or controlled by an endpoint system (EndpointWorks®). On load-lock tools, the duration of a Process step can be deferred until starting a job.

Step Termination settings are grouped on the Process Parameters tab. The settings apply to the current Process step (highlighted in the Steps box). Some Step Termination options appear only for a specific terminal method.

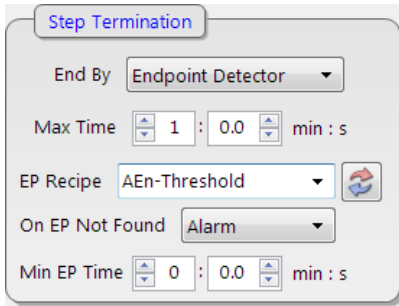

Step Termination settings on the System Parameters tab.

Step termination methods

The following settings for the timing of a Process step can be selected from the "End By" drop-down list:

Method	Purpose
Fixed Time	End the step after a specified length of time.
% Over-Etch	Add etch time based on the previous step's endpoint.
Fixed Over-Etch	Additional etch time specified in min:sec
Endpoint Detector	End the step at a signal from EndpointWorks®.
Variable Time	Set a default time that can be changed when a job starts.
Pulse Cycles	A special type of process step allows "pulsing" of process parameters. See the "pulsing" topic for more information.

After selecting the termination method, enter the settings required, such as Time, for the selected method.

Fixed Time

To specify an exact step duration, select Fixed Time. Enter the duration in minutes and seconds in the Time boxes.

Over-Etch

Two termination methods define an "over-etch" Process step. The over-etch step's duration, and whether it runs at all, depends on the preceding Process step's successful termination by endpoint. Either type of over-etch step can be canceled by the "Skip Over-etch" option described under Endpoint Detector settings, below.

Select an over-etch settings from the "End By" drop-down list:

- **% Over-Etch:** Sets the step's duration as a percentage of the previous step's *actual* duration, which is usually determined by endpoint. Enter the percentage in the Time box.
Example: If the over-etch Time value is 10%, and the preceding process step terminates by endpoint after 90 seconds, the over-etch step will be 9 seconds.
- **Fixed Over-Etch:** Select this setting to make the step's duration a fixed length of time following an etch step terminated by endpoint. Enter the over-etch time in the Time boxes in the form *minutes:seconds*.
- While a fixed over-etch step does not depend on the preceding step's duration, it can be skipped if endpoint is not found for the previous step; see the "Skip Overetch" option for "On EP Not Found," below.

Variable Time

Select this setting to allow an operator to specify the Process step's duration at the time that the recipe is used in a job. When the operator issues the Start Job command, a dialog box asks for the step duration to be entered.

Endpoint Detector settings

The screenshot shows a dialog box titled "Step Termination" with the following settings:

- End By:** Endpoint Detector (selected in a dropdown menu)
- Max Time:** 5 : 30.0 min : s
- EP Recipe:** abc.epr (with a refresh button)
- On EP Not Found:** Alarm (selected in a dropdown menu)
- Min EP Time:** 3 : 0.0 min : s

Select "Endpoint Detector" from the "End By" drop-down list to use an endpoint signal from EndpointWorks. With endpoint detection, required settings are the endpoint recipe, minimum and maximum step duration, and the result if endpoint is not found.

- **Endpoint recipe:** Select the endpoint recipe from the "EP Recipe" drop-down menu. Click the double-arrow button to refresh the list of endpoint recipes, if necessary. Endpoint recipes are created and saved in EndpointWorks.

- When a Start Job command is issued, if a valid endpoint recipe isn't specified, or the recipe no longer exists, Cortex displays an "Invalid Recipe" message.
- Minimum time:** In the "Min EP Time" boxes, enter the minimum amount of time before endpoint. If endpoint occurs earlier, Cortex posts an alarm and interrupts processing. Resolution options allow aborting the processing or restarting and resuming the current step, with the already elapsed time.
- Maximum step duration:** Enter the maximum step duration in minutes and seconds in the Max Time boxes. If an endpoint signal is not received within this time period, the "On EP Not Found" response occurs.
- On EP Not Found:** Select the result if the endpoint signal is not received before the maximum step duration ("Max Time" value):
 - **Alarm:** Interrupts processing and posts an alarm. Resolution options allow aborting or restarting processing.
 - **Warning:** Terminates the step at the "Max Time" limit, posts a warning (yellow) alert, and continues with the next step.
 - **Ignore:** Terminates the step at the "Max Time" duration and continues to the next step without posting an alarm. The Material events listing (Job History screen) reports "Endpoint Not Found" for the terminated Process step.
 - **Skip Overetch:** Skips the following step if its termination method is "Fixed Over-Etch" or "% Over-Etch." Processing continues with the step after the skipped over-etch step.

Ramping of parameter changes

Ramping can create gentle parameter changes, applying changes gradually rather than instantly. Ramping also can delay parameter changes from the beginning of Process steps.

Ramping can apply to parameters — gas flow, pressure, temperature, and RF power — that change from the previous step. Ramping can be applied to all Process steps, including looped steps.

Note: [Morphing](#) can also regulate parameter changes, but it adjusts setpoints across iterations of a loop sequence, not between steps.

To set up ramping

Select the Process step, select the Details tab, and enter values in the Ramp Delay and Ramp Time boxes. The default values are zero milliseconds.

- Ramp Time:** Sets the duration of the change from the previous setpoint to the setpoint in the current step, in milliseconds.
- Ramp Delay:** Delays the start of ramping for the specified time (in milliseconds) after the start of the step.

Example: To decrease RF power over a period of one-half second after plasma initiation, set the RF power Ramp Time to 500 ms in the Process step after the plasma initiation step. To delay starting the change for 1 second, set the RF power Ramp Delay to 1000 ms.

	Setpoint	Tolerance	Unit	Ramp Delay (ms)	Ramp Time (ms)
▶ Pressure	20.0	5.0	mTorr	0	0
ICP	125	10	W	1,000	500

Details tab: "Ramp Delay" and "Ramp Time" settings.

When ramping is applied, ramped setpoints are shaded on the Details and Process Parameters tabs. A "Ramped Parameters" indicator appears on the Process parameters tab.



Note: Color shading on the Tabular View table indicates parameter changes across steps, not ramped parameters.

Ramping considerations

- Ramping is active only when RF power is on.
- A Ramp Delay can be applied with Ramp Time = 0. This maintains the previous step's setpoint for the delay period, then changes to the current step's setpoint.

Setting up repeating process step sequences (looping)

You can insert a Loop step after any process step. A Loop step defines a *loop sequence* that consists of one or more previous Process steps. Each repetition (*iteration*) of the loop sequence is called a *loop cycle*.

In a loop sequence, **morphing** can be used to adjust process parameters across the loop cycles.

Defining a loop sequence

When a Loop step is inserted, an arrow points from the Loop step to the previous Process step in the Steps list. This indicates the start of the loop sequence. To start at an earlier Process step, select the step in the "Loop To Step" box.

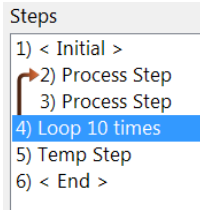

An arrow points from the Loop step to the first Process step of the loop sequence.

Loop termination

In the Loop Termination box, select a method for stopping the repetition of the loop sequence. You can specify the number of cycles (iterations), the amount of time, or an endpoint recipe.

In the Steps list, the Loop step's label indicates the termination method: the number of iterations, the length of time, or "ED" for endpoint and the recipe name.

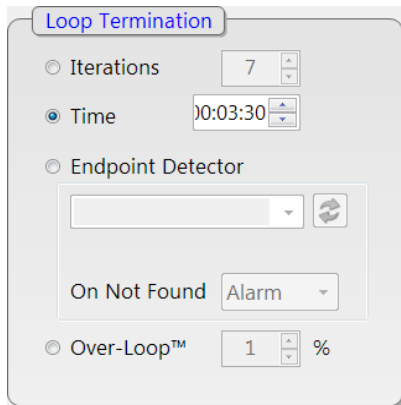

Iterations

Sets a fixed number of repetitions of the loop sequence. A value of "1" means the sequence runs once, without looping.

After an Iterations value is entered, the Time box shows the estimated duration of the loop cycles. The estimate is based on the duration of each step.

The Iterations value also applies if Endpoint Detector is selected, as described below.

Time

Sets a total duration for the loop cycle. A value of zero specifies no repetition of the loop sequence. The loop sequence repeats if the specified time has not elapsed when the Loop step

is reached. If the time elapses during the sequence, remaining steps in the sequence are completed.

When a Time value is entered, the Iterations box shows an estimate of loop cycles based on the duration of each step in the loop sequence.

Endpoint Detector

To terminate looping by endpoint recipe, select Endpoint Detector, then select the endpoint recipe from the drop-down list. Click the double-arrow button to refresh the list if necessary. The Endpoint Detector option is available only if EndpointWorks is configured and running.

On Not Found: If Endpoint Detector is selected, enter the maximum number of cycles in the Iterations box. If endpoint is not found, the loop sequence terminates after the specified number of iterations. Select a result from the "On Not Found" drop-down list:

- Alarm:** Processing is interrupted after the maximum number of iterations, and an alarm is posted.
- Warning:** The loop sequence runs for the maximum number of iterations, and a yellow alert is posted.
- Ignore:** The loop sequence runs for the maximum number of iterations, with no alarm posted.

Setting loop duration based on previous loop sequence

The Over-Loop setting can be useful in specific applications, when a first loop sequence etches aggressively to near completion, and then a less-aggressive sequence is used to avoid undercutting. The second sequence's duration is set to a percentage of the first sequence's actual duration.

For example, if the previous loop runs for 6 minutes, and the Over-Loop value is 25%, the duration of the current loop will be 5 minutes. .

Enter the percentage of the previous loop's duration to use as the current loop sequence duration.

Using 'Next Step' with loop sequences

Be aware that clicking **Next Step** on the Start Job screen does not proceed to the next step in a loop sequence. Instead, **Next Step** causes processing to jump to the step immediately after the Loop step.

Temperature step settings

You can insert Temperature steps in recipes to adjust each temperature-controlled component (or *temperature channel*). The available temperature settings depends on the configuration. For example, typical ICP modules have Spool , Lid, Liner, and Heat Exchanger temperature settings.

Temperature step parameters

Enter temperature setpoints for each channel in degrees Celsius, or select "Use Current" to maintain the existing setpoint for any temperature channel.

Waiting for temperature compliance

The "Wait for Compliance" option determines whether the recipe continues before or after the temperature channels are in compliance with the temperature setpoints, as follows:

- If "Wait for Compliance" is checked, the system waits for temperatures compliance before proceeding to the next step. If the Stabilization Timeout period elapses first, an alarm is posted.
- If "Wait for Compliance" is not checked, processing proceeds to the next step immediately. The Process Timeout tool setting determines when an alarm is posted if temperature remains out of compliance.

Evacuation step settings

Evacuation steps hold the process chamber at or below a specified base pressure for the specified time period. Enter the pressure in exponent format (1.0×10^{-3} , for example). Enter the hold time in the form *hours:minutes:seconds*.

List of recipe parameters and settings

A process recipe specifies processing parameters in a series of steps. Some parameter's set points (values to be applied) can change in each step. Process recipes can also include special steps and options, such as [ramping](#), conditional step duration, repeated sequences (looping), and others.

The following table lists all recipe parameters with brief descriptions of their effects, limitations, and other settings that may affect them. Note that a recipe is not required to contain all step types.

Settings separated by a bar (|) are exclusive options, only one of which can be selected.

Step type	Parameters	Settings and options	Description
Initial			Required first recipe step
	Hold Time		Amount of time (minutes and seconds) after reaching base pressure before next step. Note that the Initial step is always repeated if the process is restarted.
	Base Pressure		Pressure level (in the configured system units) to be reached before proceeding to the next step.
Stabilization			
	Duration	Stabilize Time	Stabilize: Cortex monitors helium flow, goes to next step after helium flow compliance. Time: Step duration is the specified time, after helium flow is in compliance.
	Pressure	Pressure Position	Pressure: Specified pressure to be maintained during the step. Position: Throttle valve position, percent open (Corial throttle valve configuration)

		only).
Gas	Gas flow rate in sccm for each available gas channel.	Specified flow rates are maintained for the step.
RF	Power level in Watts for RF generator	Same RF settings are available as for Process steps.
		Automatic: Match box controller operates matching network for optimum power delivery with minimal reflected power.
	AMN Mode: Automatic Man -> Auto Manual	Manual: Load and Tune setpoints used with 50% default values.
		Man -> Auto: Load and Tune setpoints are applied, then matching network is released to Automatic operation after time specified by "Match Box Switch Delay" (tool setting).
Chamber mode	Deposit mode Clean Mode	If Clean mode is selected, Reactor Pressure value can be entered.

Process	Main process parameters step type
----------------	--

Restart Step	(On Off)	On: Designates the step to be included if the process is restarted.
Step Termination	End By: Fixed Time % Over Etch Fixed Over-Etch Endpoint Detector Variable Time	Specifies condition to go to next step. Fixed time has "Time" setpoint only. Variable Time specifies a default time but allows the time setpoint to be adjusted by the operator when the job is submitted.
	Time	With "% Over-Etch" setting, the percentage of the previous step's duration to apply for over-etching.

	Def. Time	With Variable Time setting, the default duration for the step, which can be changed at run-time.
	Max Time	Time limit with "Endpoint" setting. Alarm is posted if the conditions to end the step have not been met.
	EP Recipe	A saved EndpointWorks recipe selected from the list. Click the adjacent button to refresh the recipe list.
	On EPR Not Found: Alarm Warning Ignore Skip Over-Etch	Result if maximum time elapses without endpoint detection.
	Min EP Time	The shortest step time allowed. If endpoint is found before this time, Cortex posts an alarm.
Pressure	Pressure	Pressure level to be maintained during the step.
Gas	Channel 1 to 8 flow rate (sccm)	Amount of gas flow for each channel throughout the step. Can be modified by ramp and morphing settings.
RF	Forward	RF power level to be applied, in watts. Can be modified by ramp and morphing settings.
	AMN Mode: Automatic Man -> Auto Manual	Automatic: Match box controller operates matching network for optimum power delivery with minimal reflected power. Manual: Load and Tune setpoints used with 50% default values. Man -> Auto: Load and Tune setpoints are

applied, then matching network is released after time specified by Match Box Switch Delay (tool setting) to Automatic operation.

Load/Tune

Match box capacitor settings to apply if AMN Mode is not Automatic.

Loop

Optional step to initiate loop sequence of Process steps

Loop to Step

Process step number to begin loop sequence

Click the step in the Loop To Step list. An arrow in the Steps box points from the Loop step to the first step in the loop sequence. The Loop Step label indicates how many times the loop repeats, either a count, duration, or endpoint detection ("ED").

Controls the loop sequence duration.

Iterations repeats the loop sequence the specified number of times.

Time repeats the loop sequence for the specified duration.

Loop Termination:
Iterations | Time | Endpoint Detect | Over-Loop

Endpoint Detect repeats the loop sequence until Cortex receives an endpoint found signal from EndpointWorks using the specified endpoint recipe. On Not Found setting specifies action to be taken (post alarm, post warning, ignore) if endpoint is not found before repeating the number of times in the Iterations box.

Over-Loop sets the current loop sequence duration as a percentage of the duration of the previously completed loop sequence.

Evacuation	Optional step type to purge gas lines and chamber
Hold Time	Duration of the evacuation process in minutes and seconds.
Base Pressure	Pressure to be maintained for the duration of the step.
End	Required final recipe step
Hold Time	Duration of step after Base Pressure setpoint compliance.
Base Pressure	Pressure level to achieve and maintain for the specified Hold Time.

Options that can affect process parameters

Parameter ramping

Ramp Delay shifts application of the parameter forward from the start of a step. Ramp Time implements the parameter change gradually over the specified amount of time (in milliseconds). These settings are on the Details tab.

Morphing of loop sequences

Morphing can adjust parameter setpoints, and the duration of process steps, for each iteration of a loop sequence. The End Setpoint and Morph factor settings are on the Details tab.

Tolerance and timeout settings

Each process parameter has *tolerance* and *timeout* settings. These settings determine how far, and for how long, the parameter's actual value can differ from the setpoint value.

Tolerances and timeouts can affect the major process parameters — temperature, pressure, gas flow, and RF power — during processing. This applies to both processing with recipes and in Manual Mode.

Details about these concepts and settings are provided in the sections that follow.

How tolerance ranges are defined

A *tolerance value* sets a process parameter's allowed deviation from a setpoint.

A tolerance value is a single value, such as 5 degrees C. The value defines a range below and above the setpoint. Therefore, the *tolerance range* is twice as large as the tolerance value (see diagram, below).

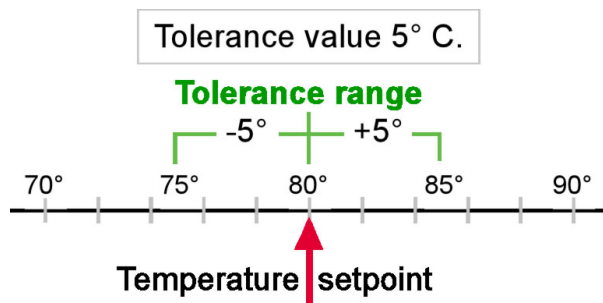

Example of tolerance range based on tolerance value.

If the tolerance value is 5° C., for example, the tolerance range is from 5° below to 5° above the setpoint, making a tolerance range of 10 degrees. If the setpoint is 80° C., the tolerance range is from 75° to 85° C.

If the actual value of the parameter is within the tolerance range, the parameter is considered to be *in compliance*. If a parameter is not in compliance for longer than the timeout period, Cortex posts an alarm.

Cortex shows parameters in compliance with bright-green shading, and parameters not in compliance with bright-yellow shading. These indicators are used on the Start Job, Manual Mode, and Gas System screens.

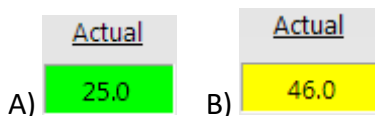

Parameter indicators:

A) In compliance

B) Not in compliance

How timeout periods are defined

A *timeout value* sets a deadline for a process parameter to be in compliance — to be within the tolerance range of the setpoint, as described in the preceding section. If the parameter's actual value is not in compliance before the end of the timeout period, Cortex posts an alarm.

Gas 1 (Gas #1) is out of compliance. Setpoint=30.000 ± 2.000, Actual=0.000 sccm.

An alarm message for gas flow compliance includes the setpoint, tolerance value (± 2.000), and actual flow.

The timeout counter is reset if the parameter achieves compliance, and the timeout counter begins counting down if the parameter goes out of compliance.

The timing of a steps in a recipe generally does not begin until certain parameters are in compliance. For example, the Initial step timer begins only after the base pressure is in compliance. The timer for a process step does not begin until gas flow is stabilized.

Overriding tolerance values in recipes

The Tolerance value for each process parameter in a recipe step are shown on the Details tab in the Recipe Editor. The default tolerance values can be overridden directly in a recipe.

In the following illustration, the Tolerance column contains default tolerance values for pressure, gas 1 and 2 flow, Bias power, and ICP power in a Process step.

	Setpoint	Tolerance	Unit	Ramp Delay (ms)	Ramp Time (ms)
▸ Pressure	30.0	5.0	mTorr	0	0
Gas 1	30.0	2.0	sccm	0	0
Gas 2	45.0	2.0	sccm	0	0
Bias	125	10	W	0	0
ICP	300	10	W	0	0

Default tolerance values (green cells) on the Details tab.

The tolerance values can be changed. They are saved in the recipe when it is saved.

To change tolerance values in a recipe step

1. In the Recipe Editor, click the Details tab
2. Click the cell containing the tolerance value to change, and replace the value with a new value.
3. Save the recipe by clicking **Save**.

	Setpoint	Tolerance
Pressure	6.67	0.67
Gas 1	30.0	5.0
▶ Bias	75	10
ICP	250	10

A changed tolerance value appears in **bold** type on the Details tab.

Setting default tolerance and timeout values

Default tolerance and timeout settings are on the Tool Settings screen or the Configuration screen. The settings and default values are listed next.

Default tolerance settings

Gas flow: The *Default Tolerance* settings for gas channels are on the PM1 Gas tab of the System Configuration screen. The default values are 2 percent of the gas channel size (in sccm).

Temperature: The *Tolerance Limit* settings are on the PM1 Temperature tab of the System Configuration screen. The default values are 5° C.

Forward and reflected power: The following RF power tolerance settings are on the Tool Settings screen:

- The RF power tolerances are at PM1/RF: *RF1 Default Power Tolerance* and *RF2 Default Power Tolerance*.
- The maximum reflected power tolerances are at PM1/RF: *RF1 Default Reflected Tolerance* and *RF2 Default Reflected Tolerance*.

In addition to tolerance ranges, Safe Limit and Maximum Reflected Power settings are on the PM1 RF tab of the System Configuration screen.

Pressure: Pressure tolerance ranges are tool settings at PM1/Vacuum:

- *Throttle Pressure Tolerance* has a default value of 5 mT (in all pressure unit configurations).
- *Throttle Position Tolerance* has a default value of 1%. This is a factory password-protected setting.

Default timeout settings

Gas flow: One timeout setting for all gas channels is at PM1/Gas: *Tolerance Timeout*. The default value is 10 seconds.

Base Pressure: The timeout for pumping to base pressure in the Initial and End steps of recipes is at PM1/Process: *Base Pressure Timeout*.

Temperature: Two settings establish timeout periods for temperature compliance:

- The timeout for temperature compliance after the Initial step is at PM1/Temperature: *Process Timeout*. The default value is 120 seconds.
- The timeout for temperature compliance before processing begins (in the Initial step) is at PM1/Temperature: *Stabilization Timeout*. The default setting is 3,600 seconds (1 hour).

RF power: Several settings for RF power operation in recipes are on the Tool Settings screen:

- The RF power compliance timeout settings are at PM1/RF: *RF1 Power Tolerance Timeout* and *RF2 Power Tolerance Timeout*. These specify the maximum time for RF forward power to achieve compliance with the RF Power setpoints.
- Reflected power timeout settings specify how long reflected RF power can exceed a specified maximum. These timeout settings are at PM1/RF: *RF1 Reflected Tolerance Timeout* and *RF2 Reflected Tolerance Timeout*.

Note: The Tool Settings screen also contains timeout settings for other processing operations, such as turbo pump startup, material clamping, and chamber venting.

Adjusting parameters in loop sequences

Parameter Morphing allows parameters to be adjusted gradually during processing. Morphing can be applied in Process steps that are in a loop sequence. For information about setting up loop sequences, see "[Recipe Step Types and Settings](#)."

Parameter Morphing is designed to facilitate etching processes that produce high-aspect-ratio features with anisotropic profiles. These processes typically require coefficient-based morphing of process parameters as etch depth increases. Looping of process steps with Parameter Morphing enables automatic scaling of alternating etch and polymer-deposition cycles.

Controls for Parameter Morphing are on the **Details** tab of the Recipe Editor. On the **Process Parameters** tab, shading indicates which parameters will be morphed.

	Start Setpoint	End Setpoint	Morph	Tolerance	Unit
Time	60.0	60.0	1.0		s
Pressure	20.0	4.0	5.0	5.0	mTorr
▶ Gas1	30.0	10	1.0	2.0	sccm
Bias	100	100	1.0	10	W
ICP	500	500	1.0	10	W

Setpoints and morphing factors can be edited on the Details tab in the Recipe Editor.

To morph process parameters

1. On the **Recipe Editor** screen, select the Process step in the loop sequence. Be sure parameter setpoint values have been entered on the **Process Parameters** tab.
2. Click the **Details** tab. The step's process parameters appear in the table. The End Setpoint and Morph values are shaded to indicate that they are associated with morphing.
3. Adjust any End Setpoint value to apply Parameter Morphing to the parameter.
4. Change any Morph value from the default value of 1.0 to apply non-linear morphing to the parameter. The Morph Curve graph represents how the parameter value will change over the loop iterations.
5. Click **Save** to save the recipe with the current settings.

Parameter Morphing definitions

The following are brief definitions of interface items and settings associated with Parameter Morphing:

Details tab: When a process step in a loop cycle is selected (in the Steps box of the Recipe Editor screen), the Details tab displays process parameters and settings in a table. For each morphable parameter with a setpoint in the step, the *Start Setpoint*, *End Setpoint*, *Morph value*, and *Tolerance* can be edited in the table. Parameters that cannot be morphed or do not have a setpoint do not appear in the table.

End Setpoint: The parameter value to be applied in the last iteration of the *loop cycle*.

Loop sequence, loop cycle: A number of process steps designated to be repeated as a set is a *loop sequence*; execution of the loop sequence during processing is a *loop cycle*. One iteration of a loop sequence (one loop cycle) refers to each step in the loop sequence running one time. The duration of a loop sequence may be determined by amount of time, number of iterations, or endpoint recipe. Loop cycle duration can be affected by morphing of the time parameter of individual steps in the loop sequence.

Morph: This value controls the rate of change for a parameter over the repetitions of a process step. Morph values are set in the grid on the Details tab.

Morph Curve: A visual representation of how the Morph value will result in changes to the parameter over loop iterations. Linear change is represented by a straight line at a 45-degree angle. Non-linear change is represented by various curves.

Start Setpoint: The parameter value to be applied in the first iteration of the loop cycle.

Setting the rate of change

When morphing is specified, Cortex gradually increases or decreases a parameter — step time, gas flow, RF power, or pressure — from the Start Setpoint, applied the first time the step runs, to the End Setpoint, applied the last time the step runs in a loop sequence. The rate of change can be linear or non-linear.

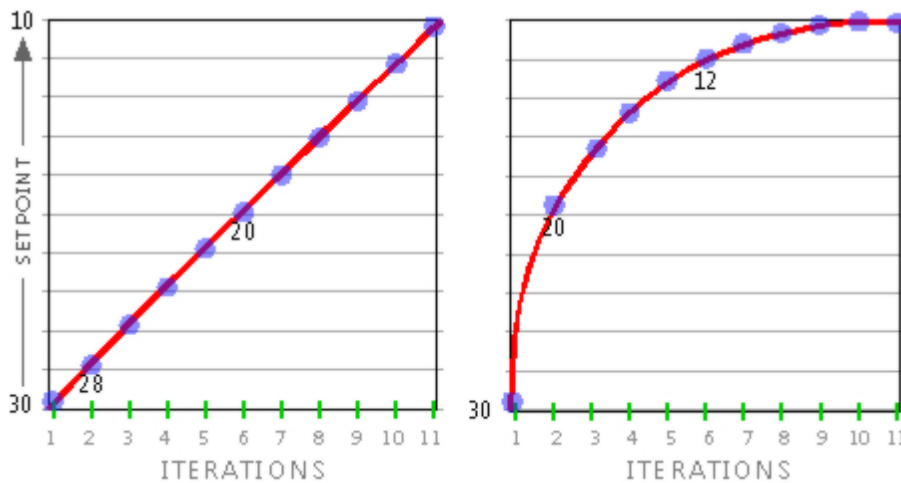

Examples of setpoint values with linear (left) and non-linear morphing. Example values at the second and sixth loop iterations are shown on the graphs.

Linear morphing

The change in the parameter from Start Setpoint to End Setpoint can be linear, increasing or decreasing by a fixed amount based on the total change and number of loop iterations.

For example, if the gas flow Start Setpoint is 30 sccm, and the End Setpoint is 10 sccm, and Loop Termination is set to 11 iterations, linear morphing decreases the flow rate evenly, resulting in a net change of 2 sccm per loop cycle.

Non-linear morphing

Morphing can also use a proprietary curve algorithm that results in the rate of change accelerating or decelerating over the loop iterations. The Morph value is specified as a number from 0.1 to 1, or from 1 to 10:

- Morph = 1 produces linear morphing (no increase or decrease in the *rate* of change).
- Morph > 1 produce greater change initially, with the rate of change falling off at the end.
- Morph < 1 produce lesser change initially, with the rate of change rising at the end.

When a morphed parameter is selected on the Details tab, the Morph Curve graphic shows the specified Morph coefficient visually.

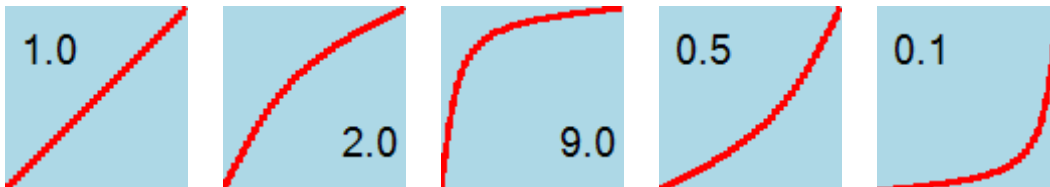

Examples of Morph Curves with various Morph values. Values > 1 have rapid change before the rate of change slows. Values < 1 have slow change before the rate of change increases.

TransFlex™ ramping of process parameters

TransFlex™ provides additional options for parameter transitions in process recipes. TransFlex provides advanced *ramping*, with complete control over the timing of setpoint changes between Process steps.

TransFlex settings are on the Transition tab (shown below) on the Recipe Editor screen. The Transition tab is available when a Process step that precedes another Process step is selected. TransFlex can be used with any Process steps, including in loop sequences.

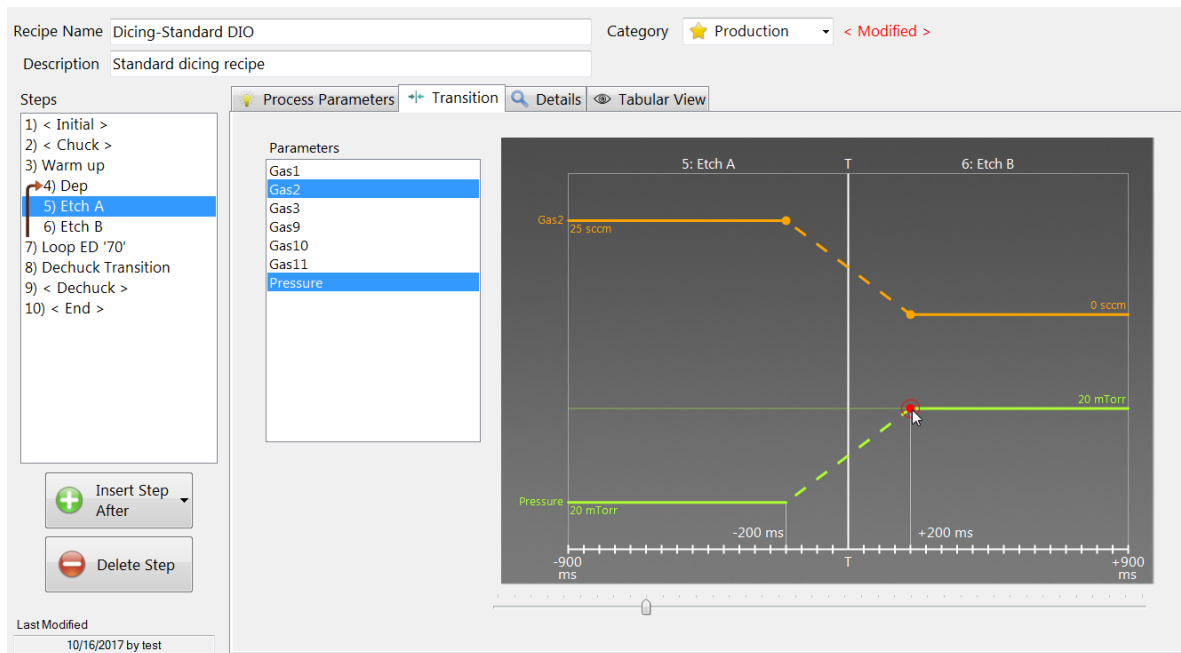

TransFlex settings are on the Transition tab in the Recipe Editor.

To set up a TransFlex transition

1. In the Steps box of the Recipe Editor, select the Process step that will start the TransFlex transition.
2. On the Transition tab, select one or more process parameters. Each parameter's setpoints appear on the chart connected by colored line segments.
3. To set the transition timing, drag the setpoints or the line segment that connects them. See the following section for more information about using the chart to adjust TransFlex settings.

Using the TransFlex chart

The chart on the Transition tab represents step transitions graphically over time. Time is represented by the X-axis at the bottom of the chart. The entire chart represents the time at the end of the selected step and the beginning of the next step. The scale can be adjusted from about 1/2 to 4 total seconds by dragging the slider below the time scale. The white vertical line in the middle of the chart (labeled "T") is time zero — the boundary between the two steps.

A process parameter is represented by a colored line. Two small circles — one higher and one lower — represent the setpoints in the two steps. Initially, all transitions are instantaneous, with both setpoints on the step boundary, connected by a vertical line segment. This segment represents the transition from one setpoint to the next.

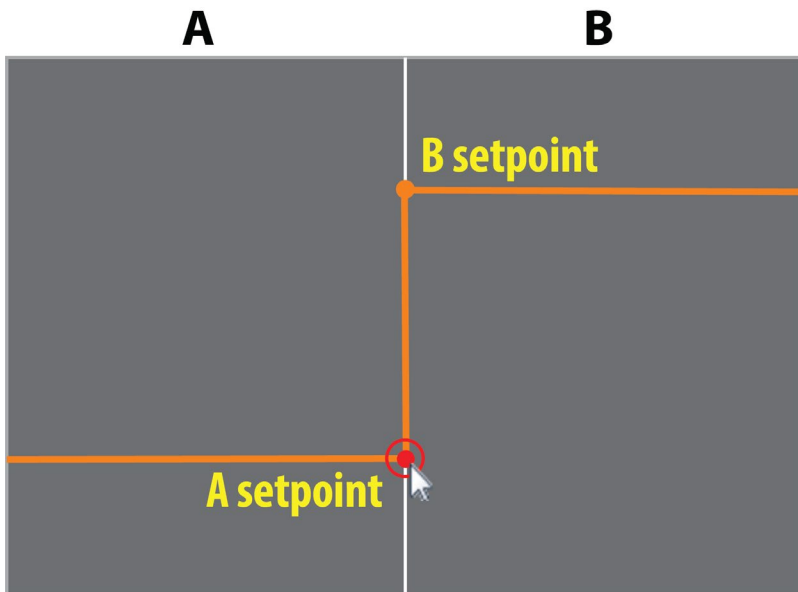

A TransFlex illustration with Process steps "A" and "B." Parameter setpoint increases at start of Step B.

In the example chart shown above, dragging the Step A setpoint to the left makes the parameter start changing earlier, before the end of Step A. This also causes the change from the Step A to the Step B setpoint to be more gradual, shown by the sloping line connecting the setpoints (next illustration).

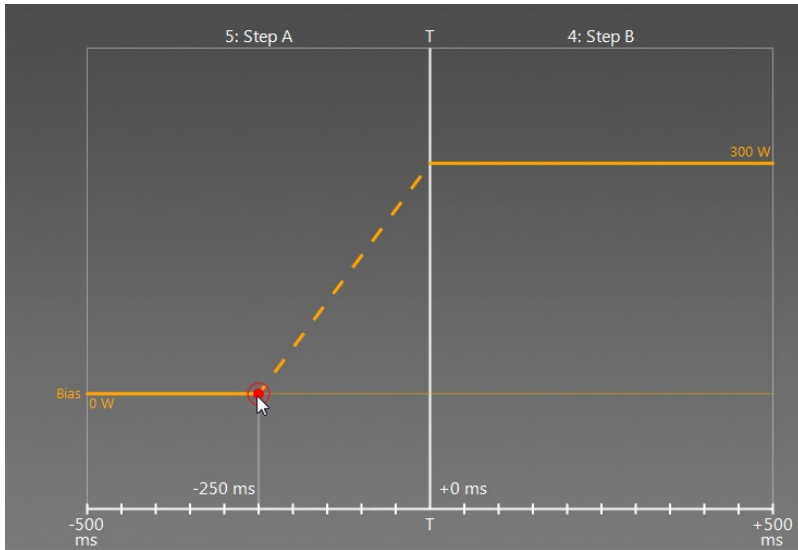

Dragging step A's setpoint to the left produces a gradual transition that is completed at the start of Step B.

There are several ways to adjust the transition between the setpoints:

- Drag a setpoint to the left to move it earlier in the transition timing.
- Drag a setpoint to the right to move it later in the transition timing.
- Drag the setpoints farther apart to make the transition between the setpoints more gradual.
- Drag the dashed transition line left or right to shift the transition relative to the step boundary, without changing the duration of the transition.
- Holding down the left mouse button with the pointer on a setpoint makes guidelines and timing values appear. This shows the exact transition starting and ending times, measured in microseconds from the step boundary.

Setting the time scale

You can increase and decrease the amount of time represented by the Transition chart. To adjust the time scale, drag the scale pointer below the chart. Drag to the left to reduce the total time; drag to the right to increase the total time.

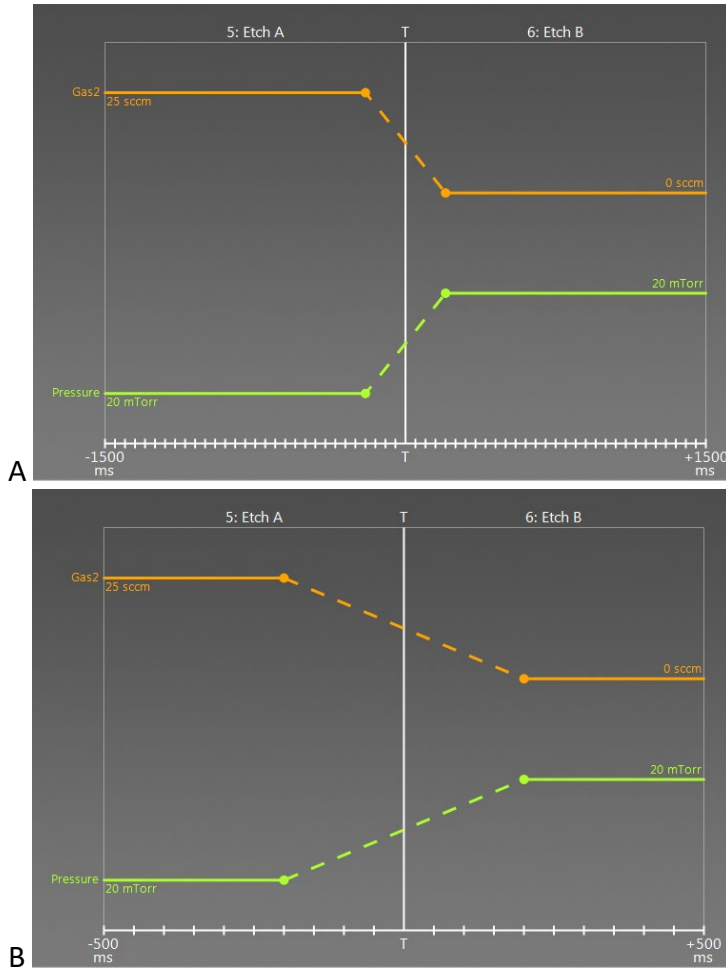

The same transitions with different chart time scales: (A) 1 second total, and (B) 3 seconds total.

Using TransFlex with loop sequences

If the last Process step within a loop sequence is selected, the TransFlex chart shows the selected step on the left, and the first step of the loop sequence on the right, because the first step follows the last step when Cortex iterates through the loop sequence.

Basic ramping compared to TransFlex

Previous versions of Cortex provided basic ramping, with delay of setpoint changes. TransFlex, in contrast, can gradually apply setpoint changes across two steps, and can start changes earlier and later than ramping.

TransFlex has supplanted basic ramping in Cortex. "Ramp Delay" and "Ramp Time" settings appear in the Recipe Editor for compatibility with existing recipes. New recipes should use TransFlex (Transitions tab) to control setpoint transitions. The Ramp values on the Details tab remain zero when TransFlex settings are entered.

Pulsing of process parameters

Cortex can apply rapid pulses of process gases, RF power, and other parameters during processing. The timing of the pulses can be easily adjusted and visualized in a graphical Pulse Editor, which is part of the [Recipe Editor](#).

The following sections describe how pulsing can be implemented in process recipes. For other process recipe settings and procedures, see "[Creating process recipes](#)" and "[Recipe step types and settings](#)."

Note: Pulsing is a special feature that is controlled by a tool setting, *System/Process/Pulse Feature*. This setting is password protected, and is set to Disabled by default. In addition, user accounts must be configured to have access to the pulsing editor. Contact Plasma-Therm customer support for more information about the pulsing feature.

Setting up pulsing in a Process step

[↑ Top](#)

A Processes step can use pulsing when the "End By" setting is "Pulse Cycles" in the Recipe Editor.

Step Termination

End By

Cycle Period secs

Cycle Count

Total Time

When "Pulse Cycles" is used, Cycle Count can be set.

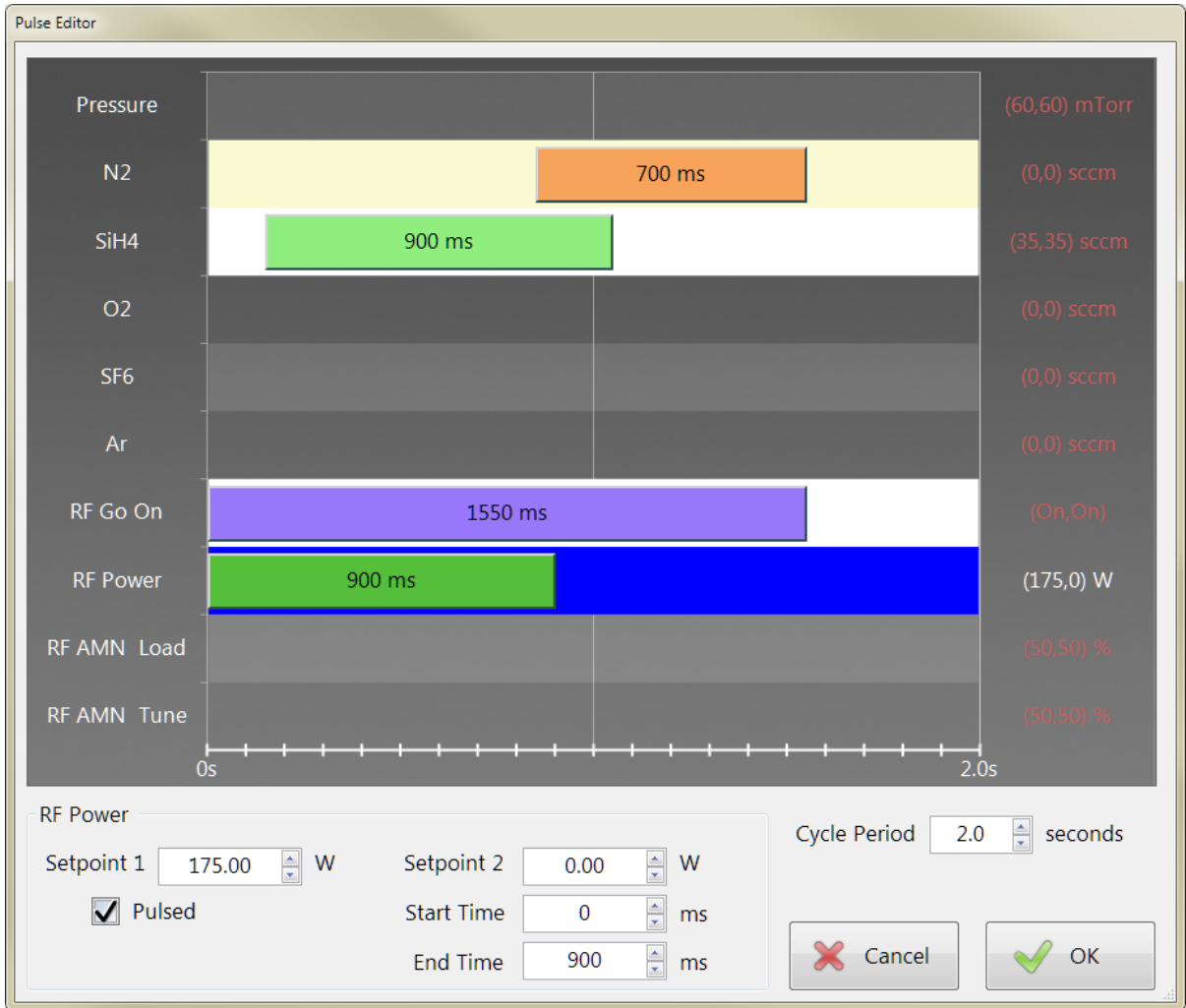

Parameters have two setpoints in the Pulse Editor. The pulse cycle is represented on a chart.

Definition of pulsing settings

In a recipe, the timing and duration of gas and RF power pulses are defined in a *pulse cycle*. The following terms are used in the Recipe Editor for pulsing settings:

Cycle Period: The length of each pulse cycle in seconds. The default is 2 seconds. The maximum Cycle Period is 60 seconds.

Cycle Count: The number of pulse cycles to execute in the Process step. The default is 30. The maximum is 9,999.

Total Time: The duration of the entire Process step, from the cycle period multiplied by the cycle count.

To set up pulsing in a Process step

1. In the Recipe Editor, select the Process step that will use pulsing.
2. In the Step Termination box, select Pulse Cycles from the End By menu.
3. Enter the number of pulse cycles in the Cycle Count box. The calculated step duration appears in the Total Time box.
4. Enter setpoints for process gases and RF settings.
5. Click the **Edit** button in the Step Termination box. The Pulse Editor appears. Set up pulses by clicking in the chart and adjusting the duration of each pulse. See “Defining pulse cycles” and the Pulse Editor diagrams, below.
6. Once the pulse cycle has been configured, click **OK**. If any pulse settings are in conflict, a message lists the invalid settings. See “Correcting invalid settings,” below.

Defining a pulse cycle

[↑ Top](#)

The Pulse Editor is an interactive chart in which a pulse cycle is defined. Bars on the chart represent pulses of vapor, reactant gas, purge gas, and RF power. Up to 10 parameter pulses can be defined.

Adding and removing pulses

The pulsing chart is blank when the Pulse Editor first opens. You can add and remove bars and adjust their timing to define the pulse cycle for the Process step.

To add a pulse

Click in a parameter row and a default pulse appears. If you hold the pointer down instead of clicking, you can move the right end of the pulse bar to adjust its duration. Repeat for each parameter to be included. You can adjust pulse position and length at any time, as described next.



A default pulse bar in the Pulse Editor.

To remove a pulse

Right click the pulse bar, and choose **Remove Pulse**.

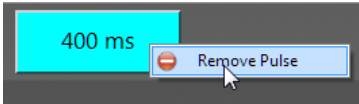

Setting the pulse timing

Each pulse is initially 400 ms long, and is placed where you click within the pulse cycle.

Pulse duration can be set in increments of 50 ms. You can adjust duration visually or by entering values:

- Drag either end of the bar to lengthen or shorten it. This also changes the start or end time.

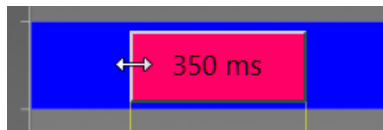

- To specify the duration numerically, double-click the bar, type the value in milliseconds, then press ENTER.
- Change the Start Time and End Time values, which determine the pulse duration.

Start Time	<input type="text" value="0"/>	ms
End Time	<input type="text" value="400"/>	ms

To set timing within the pulse cycle, you can drag the pulse bar, or set enter start and end times (see the following illustration):

- Drag the pulse bar left or right to adjust the pulse timing within the pulse cycle. Vertical lines show start and end on the time scale.
- Change the Start Time and End Time values below the chart.

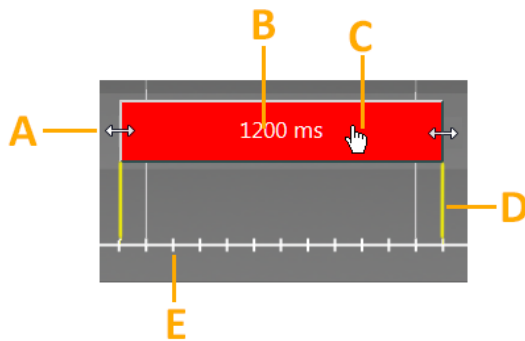

Adjusting pulse timing:

- A) Drag the left edge to move the pulse start. Drag the right edge to move the pulse end.
 - B) The pulse duration in milliseconds. Double-click the bar to edit the duration value.
 - C) Drag the bar left or right to move the start and end without changing the duration.
 - D) Yellow lines at the start and end appear when you drag the bar or a side.
 - E) Tick marks in the time scale represent 100 ms. Vertical white lines on the chart mark 1-second intervals.
-

Correcting invalid settings

When you click **OK** in the Pulse Editor, Cortex posts an alert if any settings are invalid. Cortex does not allow setpoint 1 and 2 to be equal for a pulsed parameter.

Adjusting recipes interactively

You can use the Interactive screen to develop and refine process recipes. The screen lets you run a process recipe, monitor and adjust steps and parameters, and then save the recipe with new setpoints.

Note: The [security tags](#) *Menu: Process* and *Screen: Interactive* must be unlocked to use interactive processing.

Starting interactive processing

Before using the Interactive screen, check the following:

- Interactive processing requires a saved process recipe. If necessary, [create a recipe](#) and save it in the Recipe Editor.
- Material must be in the process chamber before starting. If necessary, use the Handler > [Transfer screen](#) to load a wafer into the chamber.

To run an interactive process

1. Click **Process > Interactive** to display the Interactive screen.
2. Click **Start Job**.
3. In the dialog box that appears, click **Load Recipe**. Select a recipe in the list and then click **Load Recipe**.
4. Enter a Job ID and then click **Start Job** to begin processing.

Overview of interactive processing

Start Charting

Stop Charting

Clear All

Start Job

Abort Job

Next Step

Previous Step

Go to Step

Step Time

Resume

Save Recipe

Chartable Parameters	Recipe	Time1	Loop Elapsed	Status
<ul style="list-style-type: none"> PM1 ACAP RF On Time PM1 ACAP Wafer Count PM1 Bias AMN Load PM1 Bias AMN Load Setpoint PM1 Bias AMN Tune PM1 Bias AMN Tune Setpoint PM1 Bias DC Bias PM1 Bias Forward Power PM1 Bias Go On PM1 Bias Is On PM1 Bias Power Setpoint PM1 Bias Reflected Power PM1 Chamber Temp <li style="background-color: #e0f0ff;">PM1 Chamber Temp Setpoint PM1 Electrode Temp PM1 Electrode Temp Setpoint PM1 Gas 1 Flow PM1 Gas 1 Setpoint PM1 Gas 2 Flow 	Time1			Processing

Step Info Process Step 3 of 6

1:18.9 / 1:40.2

PM1 Gas 2 Flow	PM1 Bias DC Bias	PM1 ICP Reflected Power	PM1 Process Step Time
0.100 sccm	-2000.50 V	0.2000 W	0.500 s
0 sccm	0 V	5.000 W	78.56 s

PM1 Chamber Temp Setpoint

Min 0.00 °C

Max 500.00 °C

+ Add - Remove

Chart Span 5 Minutes

Show Flags

Charting Status Active: 2:41.6

Control Parameter	Setpoint	Actual	New Setpoint	Control Parameter	Setpoint	Actual	New Setpoint
PM1 Gas 1 Setpoint	45.0	45.0	45.0				0
			0				0

Apply

The Interactive screen can be used to monitor, adjust, and save recipe parameters.

The following features of the Interactive screen are fully described in later sections:

- Load a recipe and start processing.
- Pause, resume, and interrupt processing.
- Jump to any recipe step.
- Plot up to four process parameters (the same as on the [Charting screen](#)).
- Monitor parameter values, and apply new setpoints.
- Change the duration of steps.
- Save the recipe with current setpoints.

Using the Interactive screen

The following sections explain how to use the process controls, plot parameters, change setpoints, and save changes.

Checking process information

When a recipe is being executed, the Interactive screen displays process information. The area above the chart displays the following:

- Recipe name
- Step name
- Step number
- Process status
- Step elapsed time and total duration
- Loop sequence elapsed time and total duration

The system overview table also displays the current step number, elapsed time, and step duration. If you change the duration using the **Step Time** button, the new duration appears immediately in the table.

	Pressure	Status
AL	85.0 mT	Isolated
PM1	50.0 mT	Processing - 0:28.3 / 0:30.0 Step: 2 of 6

Parameter setpoints and values

During processing, process parameters can be added to the chart (described below) to monitor their values. The area below the can display current values for four parameters, as explained next.

Whenever a process is running, the Start Job screen displays chamber status, current setpoints and actual parameter values.

Changing process parameters

The following procedures describe how to manage processing and adjust parameters on the Interactive screen. A later section explains how to chart process parameters.

To change parameters during processing

1. When a recipe is running on the Interactive screen, click **Pause** to allow adjustment of process setpoints.
2. Press the arrow on one of the *Control Parameter* boxes and select the parameter to adjust. The parameter's setpoint and current value appear.

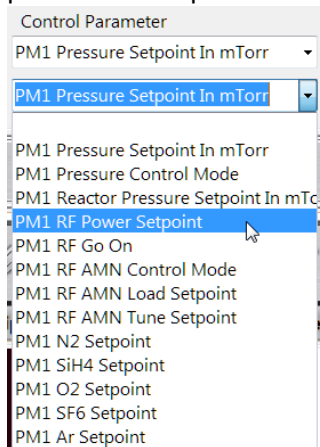

3. Enter a new value in the New Setpoint box, or, for non-numeric parameters (such as *AMN Control Mode*), select a setting from the drop-down list. Press TAB or ENTER to apply the new setpoint, or click **Apply** to implement all current *New Setpoint* values.

Control Parameter	Setpoint	Actual	new Setpt	Unit
PM1 Bias Power Setpoint	50.0	50.0	50.0	W

4. Processing continues without moving to the next recipe step until you do any of the following:
 - To resume the recipe, click **Resume**. If the duration of the current step has already elapsed, Cortex begins the next recipe step immediately. Otherwise, the step continues for its specified duration.
 - To go immediately to the next or previous step in the recipe, click **Next Step** or **Previous Step**. If processing was paused, it resumes with the selected step.
 - To go immediately to a specific step, click **Go to Step**. In the dialog box that appears, select the step and then click **Done**. If processing was paused, it resumes with the selected step.
 - To stop processing immediately, click **Abort Job**. Cortex stops processing and posts an alarm with the message "Process Interrupted: Interrupted by Operator." On the Active Alarms screen, the options "Abort processing" and "Restart process and resume step" can be selected.

To save new setpoints

1. To update the recipe with all *New Setpoint* values, click **Save Recipe**.
2. Cortex displays the setpoint changes to be made to the current step:

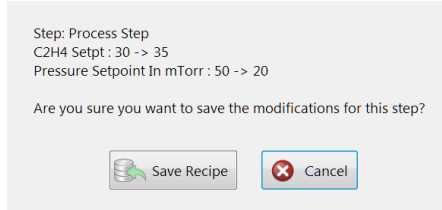

3. You can update the recipe or continue without changing it:
 - To save the listed changes, click **Save Recipe** in the message box.
 - To return to the Interactive screen without changing the recipe, click **Cancel**.

Note: If a recipe is loaded on the Interactive screen, any changes made in the Recipe Editor do not appear on the Interactive screen. You must use the **Start Job** button to load the edited version of the recipe.

To change duration of recipe steps

Do the following to change the duration of any recipe step during interactive processing:

1. Click the **Step Time** context button.
2. In the dialog box, the upper table displays the step durations in the recipe. The "Current Steps" (lower) table is for adjusting step duration; click the row of the step to adjust. The selected row is highlighted.
3. Enter the new step duration (minutes: seconds) in the New Duration boxes.
4. Click **Done** to apply the current duration settings.

Note: Changing the duration of steps does not affect a recipe. Only parameter setpoints are applied to the recipe when the **Save Recipe** button is clicked.

Charting process parameters

When processing starts Cortex clears the chart and begins plotting selected parameters. You can add and remove parameters during processing. You can set the time span for the chart, show or hide step markers, and change scaling of plotted parameters. For additional information, see the [Charting screen](#) topic.

Adding and removing parameters

Double-click a parameter in the *Chartable Parameters* list to add or remove it from the chart. You can right-click a parameter name above the chart and choose **Remove** to remove it from the chart.

Changing default scaling for parameters

To change the scaling of a parameter on the chart, click the parameter name above the chart. The name appears above the *Min Max* boxes at the left. Enter new minimum and maximum values to adjust the Y axis for the selected parameter.

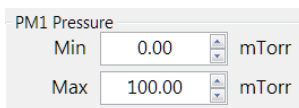

PM1 Pressure

Min	0.00	mTorr
Max	100.00	mTorr

Adjusting the chart display

Clearing the chart: Click **Clear All** to remove all plots and any selected parameters from the chart. To remove just the current plot lines, you can click **Stop Charting** and then **Start Charting** to reset the chart without removing the selected parameters.

Showing/hiding step boundaries: To show or hide the vertical lines and labels for step boundaries, click *Show Flags*.

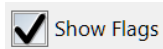

Show Flags

Changing the chart time span: Press the *Chart Span* button and select a time span, or select "Other" and then enter a time span of up to 4 hours.

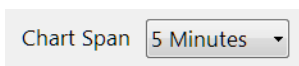

Chart Span 5 Minutes

Exporting recipes

Recipes can be exported to Acrobat PDF (Portable Document Format) files. An exported recipe file includes the following:

- Recipe name and description
- Creation date and time
- Step numbers and names
- All process parameters
- PDF file creation date and time

To export recipes

1. Click **Recipes** menu, **Edit Recipes** screen.
2. Click **Export PDF**. A dialog box opens.
3. In the *Available Recipes* list, select the recipes to export.
To select multiple recipes, press CTRL and click each one.
4. Click **Export Recipes**. Cortex displays the path to the exported files.

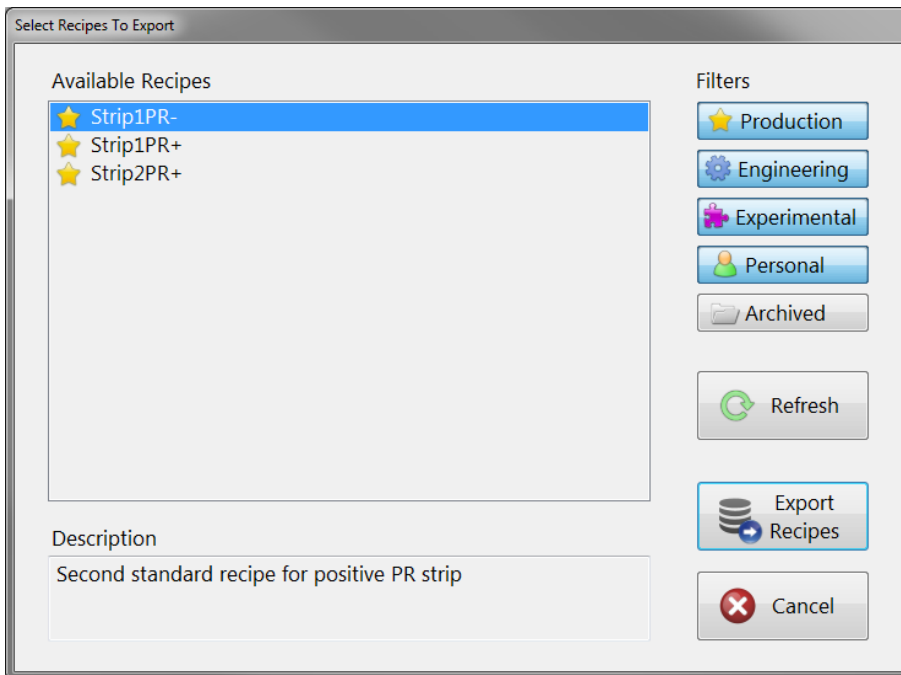

Select Recipes to Export dialog box.

CL clean job#100a

- 1) < Initial >
- 2) < Chuck >
- 3) Clean flow
- 4) < Dechuck >
- 5) < End >

Spool: 25.0 °C
 Lid: 25.0 °C
 Liner: 25.0 °C
 Electrode: 25.0 °C

ESC Voltage: 0 V
 Helium Flow: 3.0 sccm

	1. < Initial >	2. < Chuck >	3. Clean flow	4. < Dechuck >	5. < End >
Duration	0:10.0		3:00.0		0:10.0
Pressure	1.0	20.0	20.0	20.0	1.0
NH3		0.0	20.0	0.0	
Bias		50.0	50.0	0.0	
ICP		50	200	0	

Steps and parameters are included in an exported recipe.

About PDF files

Exported recipes are saved as separate PDF files in the *Cortex\Recipes\Exported PDF* folder. If the Exported PDF folder contains a file with the same name, Cortex adds a number to the recipe to create a unique file name.

Programs for various operating systems support PDF format, including the free Acrobat Reader program from Adobe. Web browsers, including Internet Explorer, Chrome and Firefox, can display and print PDF files.

Using Auto Clean & Prep (ACAP)

With Auto Clean & Prep (ACAP), Cortex can perform actions such as automatically run recipes, post warnings, or disable a process module. ACAP can improve productivity by ensuring that procedures such as running clean or chamber prep recipes happens automatically.

To set up ACAP rules, click **Recipes: Clean & Prep**.

Note: To work with ACAP rules, the logged-in [user](#) must have unlocked [security tags](#) for the Recipes menu and the Clean & Prep screen. However, once rules are set up and activated, ACAP actions take place automatically, even if the logged-in user cannot access the Auto Clean & Prep screen.

Examples of ACAP actions

The following are examples of actions that ACAP can perform:

- Run a cleaning recipe after a certain number of wafers are processed.
- Remind service personnel to perform a maintenance task after a specified number of days.
- Post an alert after RF power has been applied for some amount of time.
- Disable a process chamber when film accumulation reaches a set amount.
- Run a chamber prep recipe before switching from one type of recipe to another.
- Reset the count of processed wafers after running a clean recipe.

ACAP terms and concepts

Here are brief descriptions of the main ACAP terms and concepts:

Rules

ACAP operations are based on *rules*. A rule specifies a *trigger* and an *action*. Each rule applies to a specific process module. Cortex evaluates rules in the order they are listed in the "Active Rules" box on the Clean & Prep screen. Individual rules can be turned on or off.

Triggers

A *trigger* is a condition that Cortex monitors. The conditions include the values of ACAP *counters*, recipe tag names, and elapsed time. When a trigger condition is true, Cortex performs the *action* that the rule specifies.

Actions

The *action* specified in a rule is performed when the rule's *trigger* condition is true. Actions include running a recipe and posting a warning. Rules can also reset one or more *counters*.

Counters

A *counter* stores the number or amount of something. ACAP has counters for processed wafers, completed jobs, RF-on time, film thickness, and days. Counter values can be triggers in ACAP rules. Counter values are incremented until they are reset by an ACAP rule.

Tags

A *tag* is a label that can be applied to one or more process recipes or flows (cluster systems only). Specific tag names, or a change in tag names, can be triggers in ACAP rules.

To create an ACAP rule

1. Click **Recipes > Clean & Prep** to display the ACAP screen.
2. [Select the process module](#) the rule will operate on (cluster systems only).
3. In the *Create New Rule* box, select the Trigger for the rule. If the trigger has additional parameters, such as a counter value or tag name, enter the parameters. See "Triggers and trigger parameters" below.
4. Select an Action for the rule, and then set the required action parameters. See "Selecting actions and setting parameters" below.
5. Click **Create New Rule**. The rule is added at the end of the "Active Rules for PM" list.
6. To move the rule in the list, click an arrow button at the right of the list.
7. Click **Save** to save all current rules and settings.

How rules are executed

When you create a rule, a message tells you if the rule will execute immediately. For example, if a rule has a trigger counter, and the counter value is greater than the trigger specifies, the rule will run immediately.



Cortex also warns you if a rule that uses a counter does not reset the counter. For example, if the number of wafers counter is used to execute a clean recipe, the rule should also reset the counter.

Managing the set of rules

On	Trigger	Action	Recipe/Warning	Material	Reset
<input checked="" type="radio"/>	Tag Change	Run Recipe Before	★ Etch Prep		
<input checked="" type="radio"/>	Idle >= 1.00 hrs	Run Recipe Before	★ O2 Clean		
<input checked="" type="radio"/>	Tag = 'CLEAN'	No Action			#W
<input type="radio"/>	Idle >= 2.00 hrs	Run Recipe Before	★ O2 Clean		
<input checked="" type="radio"/>	Wafers >= 6	Run Recipe	★ FL Clean		#W

Rules can be enabled and disabled in the Active Rules box.

The *Active Rules* box shows all the rules for a process chamber. Rules are evaluated starting at the top.

-  Indicates enabled rules.
-  Indicates disabled rules.

To turn rules on or off: Double-click a rule to toggle its state. Rules must be "on" to have their trigger conditions evaluated.

To set rule priority: Select a rule and then click an arrow at the right of the box to move the rule higher or lower.

To execute a rule immediately: Select a rule in the list and click **Execute Now!** to perform the rule's action. The result is the same as if the trigger condition is true.

Selecting triggers and actions

When you create a rule, you select a trigger and specify an action. You can set up automatic cleaning for a process chamber, for example, by selecting the "After X Wafers" trigger and the "Run Recipe" action, and specifying the number of wafers and the recipe to run. When the trigger condition is true, the cleaning recipe will be run on the process chamber.

The specific ACAP options and scenarios that can be implemented on a specific system depend on the system's configuration.

Load lock-equipped systems do not have a station to hold a special cleaning wafer. Therefore, when a rule's action is Run Recipe, "Run Without Material" is selected automatically.

If material needed for a cleaning recipe is missing, Cortex disables the chamber and posts an alarm with the message "ACAP material location 'x' is empty!" When the required material is available, the ACAP operation will be executed, and then the chamber will be re-enabled.

Triggers and trigger parameters

The following are the available triggers and the required parameters:

- **After X Days:** This trigger is based on the Days counter, which goes up by 1 for each calendar day, until the counter is reset. Enter the number of days in the Days box.
Note: Cortex in simulation mode increments the Days counter once per second.
- **After X Jobs:** Enter the number of jobs (from 1 to 9999). After the system executes the specified number of jobs, the trigger is true. On load lock systems, this is the same as "After X Wafers."
- **After X Wafers:** Enter the number of wafers processed. After the specified number of wafers, the trigger is true. If the value is set to 10, for example, triggering occurs when processing of the 10th wafer finishes. The trigger value can be an integer from 1 to 9999.
- **Before Job:** This trigger performs the "Run Recipe" action before each job starts.
- **Before Job If Idle:** Specify the amount time after processing ends (from 0.01 to 999 hours). The system is considered to be active (not "idle") only when it is running a job; [manual mode](#) operation is not counted as active processing. Once the specified amount of time passes with no processing in the chamber, the trigger is true, and the "Run Recipe Before" action executes when the next job is submitted. For example, if the trigger parameter is 1 hour and the system is idle for 3 hours, and then a job is submitted, the ACAP action executes and runs the specified recipe.
- **RF On Time:** The amount of time during which the RF generator is operating (applying power). "RF On Time" includes only job processing RF operation, not operation in Manual Mode.
- **Recipe Tag:** When a recipe executes, the trigger condition is true if the Recipe Tag saved in the recipe and the one specified in the trigger setting match exactly. To add a Recipe Tag to a recipe, enter the tag text on the Properties tab in the [Recipe Editor](#) screen.
- **Recipe Tag Change:** Select an option in the parameters box: *Any Tag Change* or *Specific Tags*.
 - For *Specific Tags*, specify the tags in the *From* and *To* boxes. The condition is true only when a recipe with the *From* tag is followed by a recipe with the specified *To* tag.
 - For *Any Tag Change*, the trigger condition is true when a recipe runs and its tag does not match the tag of the recipe that ran before it. A blank tag does not match any non-blank tag.
 - To set the tag for a recipe, enter text on the *Properties* tab in the [Recipe Editor](#) screen.
- **When idle:** Enter the amount of idle time in hours after which the trigger will be true. The system is considered to be active (not "idle") only when it is running a job; [manual](#)

mode operation is not counted as active processing. This trigger can be used with several actions: Run Recipe, Disable Chamber, and Generate Warning.

- **Film Thickness:** Each time a job runs, the recipe's Film Thickness value is added to the accumulated film thickness total for the process chamber. Triggering happens when the chamber's total film thickness equals or exceeds the specified trigger value. To add a Film Thickness value to a recipe, enter the value on the Properties tab in the [Recipe Editor](#) screen.

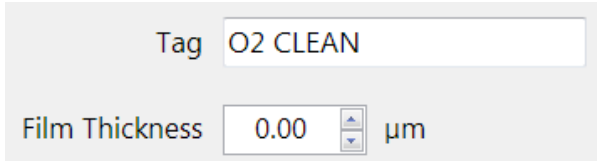

The screenshot shows a user interface for the Recipe Editor. It features two input fields: a text box labeled 'Tag' containing the text 'O2 CLEAN', and a numeric spinner box labeled 'Film Thickness' containing the value '0.00' followed by a unit symbol 'µm'. The spinner box has up and down arrows for adjusting the value.

Recipe Tag and Film Thickness values are entered on the Properties tab on the Recipe Editor screen.

Actions and action parameters

Here are descriptions of the ACAP Actions. Refer to the table below to see the actions available for each trigger setting.

Note: On load-lock equipped Corial systems, "Run Recipe" actions that could be executed without material are not available. Corial 200 load lock systems require material to be present in the process chamber when any recipe is executed.

- **Disable Chamber:** No parameter needs to be set. On a single-chamber system, any jobs selected to run will generate an alarm. On cluster tools, disabling a chamber prevents a job from running only if the job targets the disabled chamber alone; jobs that have parallel flows to other chambers will run, bypassing the disabled chamber.
- **Generate Warning:** Type a warning message in the Message box. The text will be included in the warning alarm posted when the rule executes. The text will appear in the Info box in the Status bar, and on the Active Alarms screen.
- **No Action:** This action is used for resetting counters (described next) without performing another operation, such as running a recipe. The Reset Counter checkboxes control which counters are reset when a rule executes. Selected counters that will be reset have a checkmark.
- **Run Recipe:** Specify the recipe and select a material option from the Clean/Prep Wafer drop-down menu. On Load Lock systems, "Run Without Material" is the only option. On cluster systems, any of the tool's buffer stations can be selected as the location for a cleaning wafer.

- Run Recipe Before** or **Run Recipe After**: Click **Select**. In the dialog box, select a recipe from the list and then click **Select Recipe**. The recipe's name appears in the Recipe box. Then, select a setting from the Clean/Prep Wafer drop-down menu. In some cases, only "Run Without Wafer" is available. On Load Lock systems, "Run Without Material" is the only option. On cluster systems, a buffer station can be selected. When "Run Recipe Before" or "Run Recipe After" is selected, the specified recipe will run before/after the wafer that makes the trigger condition true runs or is scheduled to run.

Availability of actions

The actions that can be selected for a rule depend on the trigger condition that is selected. The following table shows which actions can be selected for each trigger. Note that some actions are not applicable to load lock systems where ACAP actions cannot run automatically.

Triggers	Actions					
	Run Recipe	Run Recipe Before	Run Recipe After	Generate Warning	Disable Chamber	Reset counters
After X Days	x	x	x	✓	✓	✓
After X Wafers	✓	x	x	✓	✓	✓
After X jobs	✓	x	x	✓	✓	✓
RF On Time	✓	x	x	✓	✓	✓
Film Thickness	✓	x	x	✓	✓	✓
Recipe Tag	x	✓	✓	x	x	✓
Recipe Tag Change	x	✓	✓	x	x	✓

Before Job If Idle	x	✓	x	x	x	✓
When Idle	✓	x	x	✓	✓	✓
Before Job	✓	x	x	x	x	✓

✓ Available Action.

x Action not available.

Resetting ACAP counters

If a counter is not reset, trigger conditions that use the counter remain true, even after specified actions have been performed. For example, if the trigger "After X Wafers" is used in a rule, and the system reaches the specified number of wafers, Cortex will perform the specified action after every wafer until the counter is reset, or the rule is turned off.

When a rule executes, counters are reset immediately, before other actions. If a rule is set up to run a recipe and also to reset counters, it is possible for the counters to be reset although the recipe is stopped before it runs completely.

It's recommended that when a counter is used in a rule, and the rule runs a cleaning or prep recipe, a separate rule with the Recipe Tag trigger should reset the counter when the recipe runs. Because recipes can be run separately from ACAP by using the Start Job screen, a cleaning recipe could be run more often than necessary, unless the counter that triggers it is reset whenever the recipe runs.

To do this, in the Recipe Editor, assign a tag such as "CLEAN" to the cleaning recipe. If an operator executes the cleaning recipe using Start Job screen, a rule with the *Recipe Tag* trigger and the parameter "CLEAN" will reset the counter that would automatically perform the clean recipe action.

When a rule's action is "Run Recipe [Before/After]," and the Clean/Prep Wafer setting specifies that a cleaning wafer will be used, the action does not increment the count of processed wafers that is monitored for the "After X Wafers" Trigger condition. The rule can, however, reset the "# Wafers" counter to zero, if that option is selected.

Using ACAP controls and settings

Active Rules for PM1

On	Trigger	Action	Recipe/Warning	Material	Reset
	Tag Change	Run Recipe Before	★ O2 Clean		
	Idle >= 1.00 hrs	Run Recipe Before	★ O2 Clean		
	Tag = 'CLEAN'	No Action			#W
	Idle >= 2.00 hrs	Run Recipe Before	★ O2 Clean		
	Wafers >= 6	Run Recipe	★ FL Clean		#W

Double-click a rule to toggle it on/off.

Create New Rule

Trigger: Recipe Tag Change

Action: Run Recipe Before

Parameters (Trigger): Trigger when a recipe with a different tag than the prior recipe is run.

Parameters (Action):
 Recipe: ★ O2 Clean
 Clean/Prep Wafer: Run Without Material
 Run a clean recipe (with or without material) before the production recipe has run.

Reset Counter:
 # Wafers
 # Jobs
 RF On Time
 Film Thickness

Buttons: Remove Rule, Execute Now!, Create New Rule, Update Rule

- 1) List of rules for PM1. The first rule is selected; its settings appear below the list.
- 2) The rule's Trigger, "Recipe Tag Change."
- 3) The rule's Action, "Run Recipe Before." Recipe and Wafer parameters are specified on the Parameters tab.
- 4) Reset options for counters. None are selected for this rule.

Overview of processing features and methods

On Corial load-lock systems (210 IL, DL, etc.), you use Cortex to run and manage processing jobs. Cortex offers both manual and recipe-based processing. These methods are described briefly here.

Using recipes for processing

Recipes are saved sequences of processing steps and parameters.

- To create, save, and edit recipes, use the [Edit Recipe](#) screen.
- To run jobs, use the [Start Job](#) screen.

Operating the load lock

The Corial load lock has physical buttons for operating the lid, pumping and venting the chamber. The same functions are available in Cortex on the Start Job screen. See the sections about [starting jobs](#) and [using the load lock](#) for more information.

Manual processing

Process parameters can be applied under manual control on the [Manual Mode](#) screen. Manual mode allows temperature, gas flow, pressure, and RF power to be applied adjusted during processing, without using a saved recipe.

Interactive processing

The [Interactive screen](#) combines several features in one location. It provides the ability to adjust process parameter setpoints while a recipe is running, and to update the recipe with the changes.

To use the Interactive screen, click **Process** and then click **Interactive Process** in the Navigation panel.

On the Interactive screen, you can load a recipe, initiate processing, adjust parameters, and save the changes. You can click a context button to change the recipe progress:

- To skip immediately to the next or previous recipe step: **Next Step** or **Previous Step**
- To interrupt processing: **Abort Job**
- To go to a different step: **Previous Step**.
- To apply the current setpoints to the loaded recipe, click **Save Recipe**.

Changes to a recipe affect the saved version of the recipe. If you want to keep an original version and a modified version, make a copy of the recipe first by changing its name or category on the Edit Recipe screen, and then click **Save**.

Monitoring, charting, and other processing features

The following are additional features related to running jobs and process data:

- [Control processing](#) on the Start Job screen and [handle alerts](#) during processing on the Active Alarms screen.
- [Plot process parameters](#) during processing on the Charting screen.
- Set up jobs to run automatically on the [Auto Clean & Prep](#) screen.
- Review processing steps on the [Job History](#) screen.

Note: Access to menus, screens and commands depends on the [security settings](#) of the logged-in user.

Disabling and enabling the process module

The process module (PM1) can be disabled, which prevents process jobs from being run. An operator can disable and enable the process module, as long as the security settings for the user account provide access to the Module Mode screen and its context buttons.

The disabled module mode does not prevent the use of the Manual Mode screen to apply process parameters.

The process module can be disabled automatically by an [Auto Clean & Prep \(ACAP\)](#) rule. ACAP rules take action based on a specified trigger or condition. If the process module has been disabled by ACAP, a user must enable the module before it can be used for process jobs.

When a module is disabled, the text "Off-Line" appears in red on the system overview and on other screens that display a system graphic.



The "Off-Line" label appears when the process module is disabled.

To enable the process module

1. Click Service > Module Mode.
2. On the Module Mode screen, click **Enable PM**.

To disable the process module

1. Click Service > Module Mode.
2. On the Module Mode screen, click **Disable PM**. The text "Off-Line" appears on the system overview graphic.

Running process jobs

Two basic processing methods are available on Corial systems:

- **Recipe processing:** Processing is controlled by a saved recipe, which specifies all process setpoints and steps.
- **Manual mode:** Process parameters and timing are controlled by the operator. See the [Manual Mode](#) topic for more information.

Processing with recipes

Use the following procedures to start a job using a recipe. Information about job requirements and options is included after the procedure.

Preparing for process jobs

The following are prerequisites for starting process jobs:

- **System ready.** Cortex must be running, and the system must be ready, with no [active alarms](#).
- **Saved process recipe.** The recipe to use must have been created and saved. The logged-in user must have access to the recipe category. See "[Creating process recipes](#)" and "[Controlling access to features](#)" for more information.
- **Material loaded.** An unprocessed wafer must be on the material carrier in the AL (load lock) chamber. Or, the material can be in the process chamber if the option "No Transfer" (described below) is selected.

To start a process job

1. Click **Process** and **Start Job**, if necessary, to display the Start Job screen.
2. Available [process recipes](#) are listed in the Recipes box. Click to select the recipe to use. The selected recipe name becomes highlighted.
3. Type a job identifier in the "Job ID" box. A job ID may be optional or required, depending on the [tool setting](#) for "Job ID Requirement."
4. Select or clear the "No Transfer" and "Auto Vent" options (described below).
5. Click the **Start Job** button. A message asks for confirmation to close the load lock lid, if necessary. Click OK to continue.

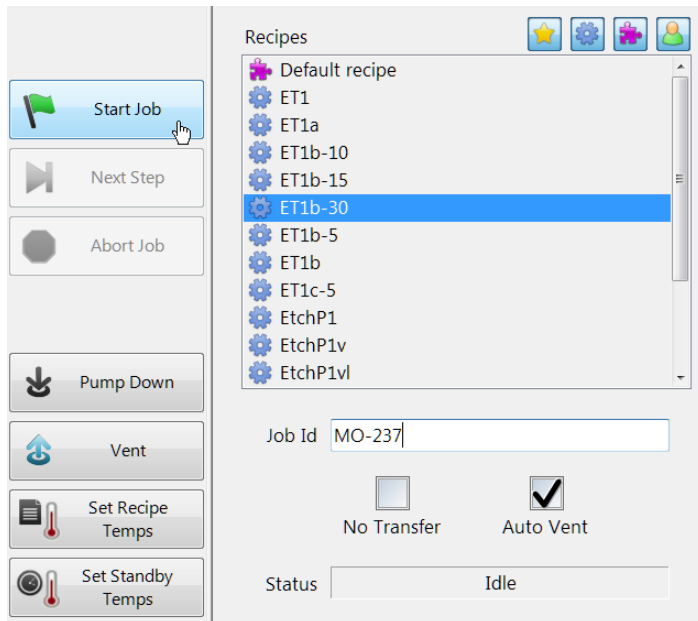

Start Job screen with a selected recipe, Auto Vent selected, and Start Job button highlighted.

Material, vacuum, and temperature control

Loading and transferring material

The Corial system requires material to begin a job. Cortex posts a message if you try to start a job without material.

After placing material in the load lock, the lid can be closed and the chamber pumped down using the "Vacuum" buttons on the front panel, or the **Pump Down** button on the Start Job screen. If the lid of the load lock remains open too long, Cortex posts a warning (yellow) alert.

If the load lock lid is open when the **Start Job** or the **Pump Down** button is clicked, a message warns that the lid will close. Click **OK** to close the lid and continue. Clicking **Cancel** will stop the operation.

If the material to be processed is already in the process chamber, select the "No Transfer" check box on the Start Job screen. When the operator clicks **Start Job**, Cortex starts the selected recipe without making a transfer.

Auto venting after processing

To automatically vent and open the load lock after processing, select Auto Vent on the Start Job screen. If the "Auto Vent" box is checked, Cortex transfers processed material from the

process chamber to the load lock, and then vents the load lock. The "Auto Vent" option cannot be selected if the "No Transfer" option is selected.

Load lock vacuum control

Buttons on the Start Job screen control the vacuum state of the load lock. The buttons are not available while processing is active.

- Click **Pump Down** to pump down the chamber. If the lid is open, a message asks for confirmation. Click **OK** to close the lid and begin pumping.
- Click **Vent** to vent the chamber to atmosphere.

The Info box shows pumping and venting status messages. The [system graphic](#) displays light blue background shading when a chamber is vented. The signal tower's blue light blinks during venting, and is lighted when the chamber is vented. The lid opens automatically when the load lock is vented. See ["Operating the Load Lock"](#) for more information.

Applying temperature setpoints

Before starting a job, the system can be brought to a specified standby temperature or recipe temperature setpoints:

- Select the recipe in the Recipes box, then click **Set Recipe Temps** to implement the temperature setpoints specified in the recipe's Initial step.
- Click **Set Standby Temps** to use the standby temperature setpoints, which are specified on the Temperature Configuration screen.

Monitoring and controlling jobs

When the system is running a job, the Start Job screen shows the recipe name, current step, elapsed time, and all setpoints and actual parameter values. [Cell colors](#) indicate parameter compliance. The **Abort Job** and **Next Step** command buttons are available (unless restricted by user account settings).

Ending recipe steps

To skip immediately from the current recipe step to the following step, click **Next Step**. The system implements the parameters specified in the next step. Cortex updates the step information shown on the Start Job screen.

Interrupting and stopping jobs

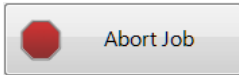

To stop processing immediately, click **Abort Job**. Cortex interrupts the recipe, stops gas flow and RF power. The chamber is pumped down. Temperature setpoints remain at the recipe values.

Cortex posts an alarm (a red alert) when processing is interrupted. Click the Alarm box or click **Alarms: Active Alarms** to go to the Active Alarms screen.

Typically, two resolution options are available: "Abort Processing" and "Restart Process and resume step." Click either of the resolution buttons. If you choose "Restart process and resume step," Cortex runs the Initial step, then runs any designated Restart steps, and the step that was interrupted, in sequence.

At the time a job is interrupted, if all process steps have already been completed, the resolution options are "Resume Step" and "Abort Job."

The Job History screen indicates when Abort Job was requested during recipe processing, and shows the time of job termination.

Setup and operation of the load lock

The load lock module has a vacuum chamber and a robotic arm that transfers material to and from the process chamber. The load lock is designated "AL" on the system overview

More than one type of load lock can be configured on Corial 200 systems. The type is specified by the "Handler Type" setting on the System Configuration screen. There are currently two types available:

- "Corial Load-Lock" is standard on older systems. This load lock has an automatic lid and front-panel control buttons.
- "Hine SL" load lock is typically configured on new systems. This load lock has a manually operated lid. It does not have a front panel with control buttons.

Differences in operation between the two types of load lock are noted in the text.



A



B

- A) Corial Load-Lock
B) "Hine SL" load lock

Using the load lock

Note: Vent and Pump Down buttons on the Start Job screen apply to the lock chamber, even when the [system focus](#) is on the process chamber (PM1).

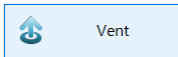
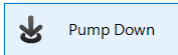

Buttons on Start Job screen

To vent and open the load lock

On the Start Job screen, click **Vent**. The lid action depends on the module type:

- Hine SL:** When the chamber is fully vented, lift the lid to the open position.
- Corial Load-Lock:** When the chamber is fully vented, the lid opens automatically.

To close and pump down the load lock

- Hine SL:** Close the lock chamber lid, if necessary. On the Start Job screen, click **Pump Down**.
- Corial Load-Lock:** On the Start Job screen, click **Pump Down**. Cortex posts a yellow warning alert with the message "The lock lid will close. Please Confirm." On the Active Alarms screen, click **Close Anyway** to confirm closing the chamber. When pumping starts, the lid closes automatically.

To use the front panel (Corial Load-Lock only), simultaneously press both **Vacuum** buttons. The lid closes automatically.

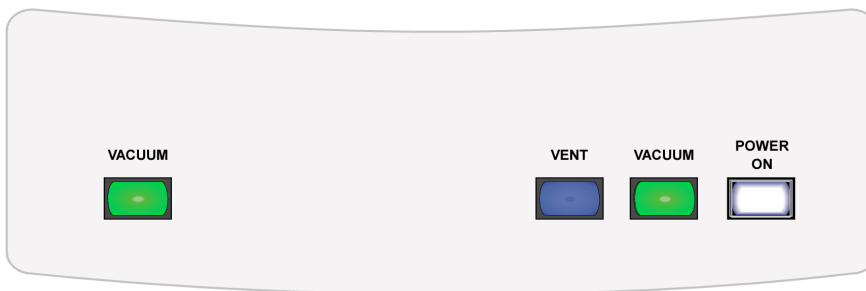

Front-panel buttons ('Corial Load-Lock').

Note: If the process chamber is being pumped down, this process must finish before the load chamber can be pumped down.

Automatic lid operation ('Corial Load-Lock' only)

The chamber lid opens and closes automatically. Do not try to open or close the lid by hand. Venting the load lock causes the lid to open. Pneumatic pressure in the lid struts supports the lid in the open position. Pumping down removes the pressure and allows the lid to close.

Venting the process chamber

Venting of the process chamber can be done from the Service: Vacuum screen. A single line supplies nitrogen gas to the load lock for venting, so the lock must also be vented in order to vent the process chamber. Before venting the process chamber, it may be necessary to pump down the load lock to equalize pressure so the slot valve can be opened.

1. Set the system focus on the process chamber (PM1).
2. On the Service: Vacuum screen, click **Vent**.
3. Cortex posts a yellow alert: "The chamber will be vented. Please Confirm." On the Active Alarms screen, click **Vent Anyway** to vent the process chamber.

Material sensing

Material sensing is done by a laser mounted below the load lock, which is aimed at a reflector on the lid. When material is present on the robot arm, the material interrupts the laser beam. This signal provides the material presence condition to Cortex.

The overview graphic in Cortex shows the location of material in the system. The color of a wafer indicates its condition. See "[Indicator colors for material and parameters](#)" for more information.

Testing material transfer mechanisms

Testing of the transfer mechanisms can be performed from the Handler: Cycle Test screen. Use the controls to initiate and stop transfers and arm testing. You can also review previous test data on the screen.

Use the Duration options and context buttons, described next, to set up, start, and stop testing of transfer operations.

Setting the test duration

For tall transfer testing, select one of the following options in the Duration box:

- Number of Cycles: Enter an integer value up to 5,000
- Fixed Duration: Enter the time period as hours:minutes:seconds, up to a maximum of 23:59:59.

- Continuous operation: Select "Until Stopped." Testing will continue until ended by the **Stop** button.

Starting and ending testing

After setting the duration, click a button to begin testing.

- Cycle Transfers:** Click to begin testing material transfers.
- Cycle Arm:** Click to begin testing robot arm cycles.
- Stop:** Click to end the current test.

Transfer mechanism settings

When the system is first commissioned, the transfer robot must be taught before transferring any material.

The Handler: Teach screen is used to position the robot arm and to save position settings. Buttons allow opening and closing the slit valve between the load and process chambers, and moving the cathode (material platform) to its top and bottom positions.

Transfer positions

These are the defined positions of the transfer arm and cathode, which operate together during material transfers.

- Arm positions:** The transfer arm extends and retracts only. The arm does not move vertically.
- Home and Retract are at position 0 (approximately). Only the Hine SL load lock has a Retract position setting that can be changed on the Teach screen; the default setting is 10.
- Extend is at position 10000 (approximately)
- Cathode positions:** The cathode rises to lift material from the transfer arm end-effector. It lowers to place material on the end-effector.
The arm can be extended and retracted with the cathode in either the Top or Bottom position.
- Homing the robot:** Clicking **Home** retracts the arm fully.

Transfer into process chamber

These actions occur when material is transferred from the load lock into the process chamber:

1. The material carrier is placed on the end effector, the lock lid is closed, then the lock is pumped down.

2. When pressure is equalized, the slit valve is opened.
3. The cathode is at the Bottom position. The transfer arm moves into the process chamber to the Extend position.
4. The cathode moves to the Top position, lifting the material carrier off the end-effector and placing it in contact with the mechanical clamp, in the process position.
5. The arm moves out of the process chamber, back into the lock, to the Retract position.
6. The slit valve closes.

Transfer into load lock

These actions occur when material is transferred from the process chamber back to the load lock:

1. The material carrier is on the cathode, which is at the Top position.
2. The slit valve opens.
3. The arm moves to the Extend position.
4. The cathode moves to the Bottom position, which places the material carrier on the transfer arm end-effector.
5. The arm moves out of the process chamber, back into the lock, to the Retract position.
6. The slit valve closes.
7. The load lock is vented and opened for removal of the processed material.

Setting transfer arm positions

The Teach screen is used to set the transfer arm positions. Buttons operate the arm, and can be used to manually control the slit valve and cathode as well. Buttons are also used to set the taught positions. The screen includes status indicators for the arm, slit valve, and cathode. These are important to observe for safe operation of the load lock.

This section applies to all load lock handler types. There are minor differences between the teaching controls for the Corial Load-Lock and the Hine SL load lock:

- The Hine SL load lock Teach screen has an explicit setting for Retract Position; the Corial Load-Lock Teach screen lacks this setting.
- The Hine SL load lock Teach screen has a Toggle Servo button, which is not present on the Corial Load-Lock Teach screen.

Jog: Click the Forward and Backward buttons to move the arm by the distance in the Amount box.

Direct Move: Enter a position value in the text box, and then click the arrow button to move the arm to the specified position.

Go To: Click **Go To Extend** or **Go To Retract** to move the arm to the position values that have been saved for Extend or Retract.

Setting a position value: The exact current position of the arm is the value in the "Current Position" box. To make this position a saved position, click **Set Extend** or **Set Retract**, depending on the position to be saved. Retract position is available only on the Hine SL load lock.

Saving current settings (Hine SL only): After changing an arm position setting by clicking a "Set..." button, click **Save**. If there are unsaved changes when you try to leave the Teach screen, Cortex posts a confirmation message.

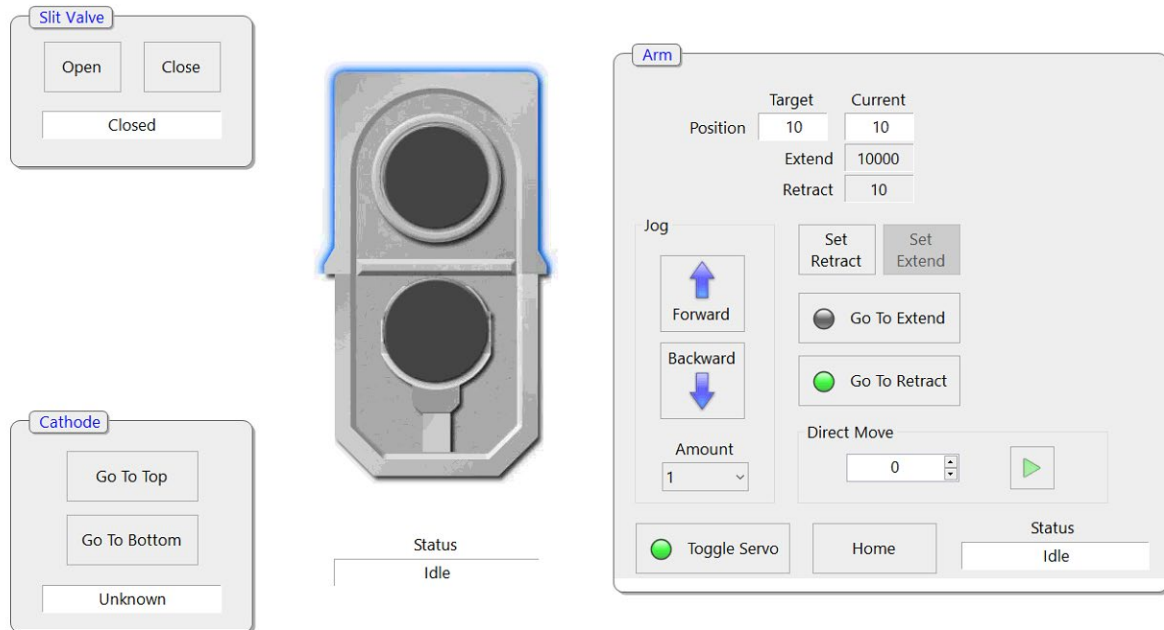

Teach screen: Movement controls and status indicators for the slit valve, cathode, and transfer arm (Hine SL load lock).

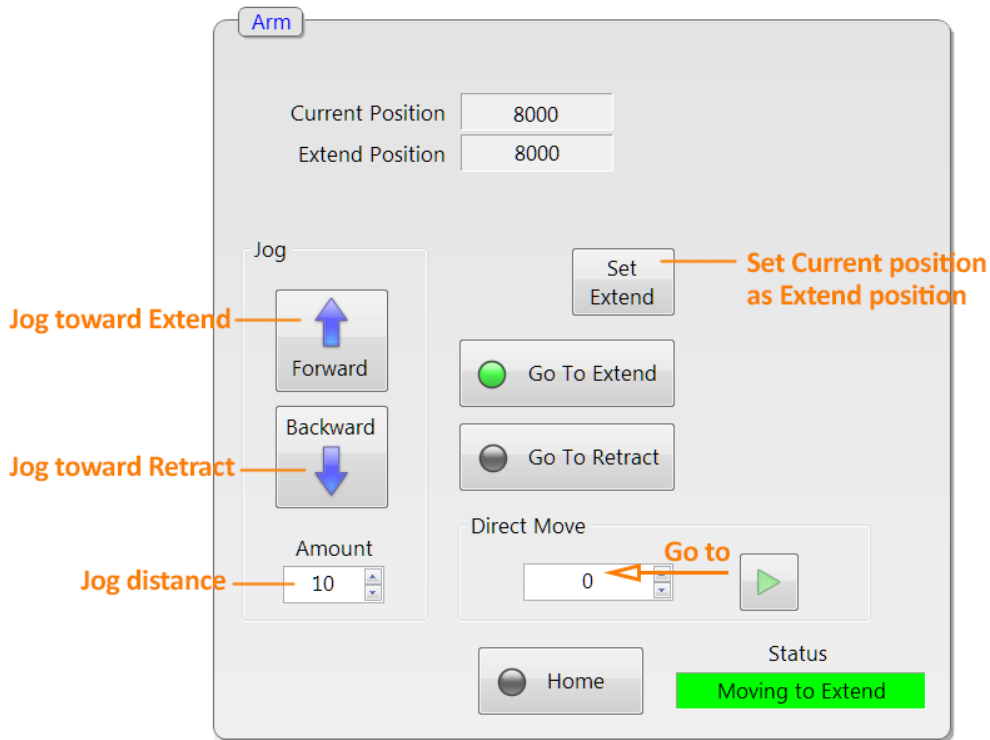

Arm controls for "Corial" load lock on the Teach screen.

I/O signals

The following table lists load lock control and status signals that are displayed on the Service: I/O screen.

Digital Inputs	Digital Outputs	Analog inputs	Analog Outputs
AL Lid Is Closed	AL Open Lid	AL Pressure (mT)	Arm Position Setpoint
AL Has Material	AL Open Rough Valve	Arm Position	
AL Rough Valve is Open	AL Open Vent Valve	Arm Real Position	
Slit Valve is Open	Open Slit Valve		
Slit Valve is Closed	Close Slit Valve		

Arm is At Home

Retract/Extend Arm

Arm is Extended

Arm Is Retracted

Processing in Manual Mode

In **Manual Mode**, process parameters can be applied without using a recipe. Manual Mode is designed to help process engineers develop recipes, and can be used by service personnel to operate subsystems without running recipe jobs.

The [security settings](#) for the logged-in user account determine if Manual Mode is available.

CAUTION: Cortex does not monitor Impedance matching during manual processing. Therefore, RF operation must be closely monitored to prevent damage to RF sources. If a plasma fails to light, reflected power can exceed the maximum reflected power tool setting, without Cortex posting an alarm.

Note: If the process chamber does not contain material (or an empty carrier), RF power cannot be applied. If the RF subsystem is turned on, Cortex posts a warning alert, and does not apply RF power.

To use Manual Mode

1. Click **Process** and **Manual Mode** to open the Manual Mode screen.
2. Enter setpoints for process parameters: temperature, chuck helium, process gases, chamber pressure or throttle-valve position, RF power, matching network settings.
3. Select fixed or open-ended duration:
 - Select "Fixed Time" and enter the process duration (hours:minutes:seconds).
 - Select "Run Until Stopped" to continue processing until stopped by an operator.
4. To activate process parameters, click **Temp On**, **Gas On**, **Chuck On**, **Pressure On**, and **RF On**. Gas, pressure, and RF subsystems must be started in sequence. **Pressure On** is not available until gas is active; **RF On** is not available until gas and pressure are active.

To end manual processing

Click **All Off** to stop processing. The operator can stop manual processing at any time.

To turn off individual subsystems (pressure, temperature, gas, etc.), click the "Off" button or the subsystem label.

The Manual Mode screen

You can click a subsystem label at the top of the main panel to activate or de-activate a subsystem. This is the same as clicking the On/Off buttons in the left panel. The subsystem labels indicate status.



- Gray:** Not active
- Yellow:** Active, not in compliance
- Green:** Active and in compliance

Parameter and value displays

The Manual Mode screen shows actual temperature, pressure, gas flows, and other parameters during manual processing. Color indicates when actual values are in compliance (green) or not in compliance (yellow) with the current setpoints.

The Manual Mode screen also shows actual parameter values when a job using a recipe is running. However, the setpoints on the Start Job and Manual Model screens are independent, and color shading is not used to indicate parameter compliance.

Timer display

At upper right of the main panel, elapsed time or time remaining is shown, depending on the Time option that is selected:

- Run Until Stopped:** Elapsed time is displayed, and processing continues until stopped. Click **All Off** to stop all subsystems, or click the "Off" buttons for individual subsystems.
- Fixed Time:** The timer counts down from the specified process duration. When the timer reaches zero, Cortex turns off all subsystems.

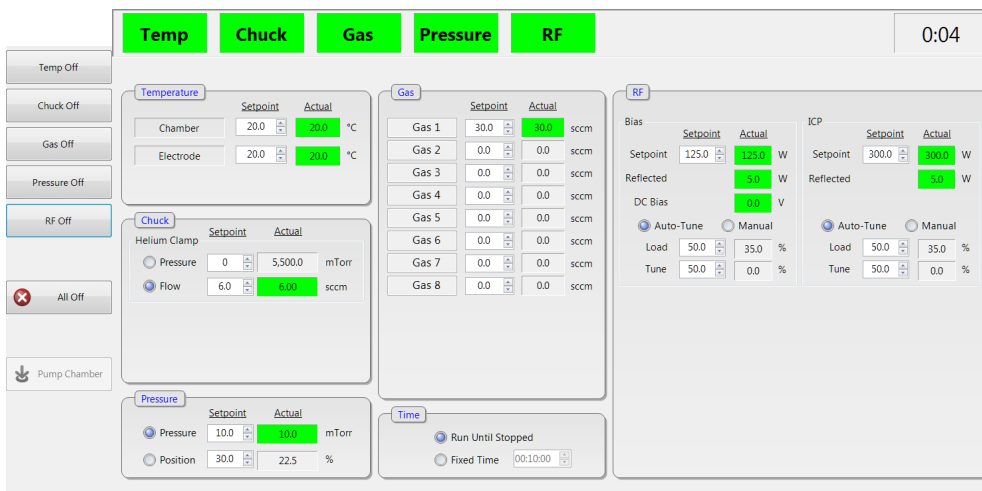

Manual Mode screen: Context buttons, left, and main panel showing all subsystems are active.

Manual processing history

The Job History screen displays information about all processing activities on the system, including Manual Mode. In the Jobs box, recent manual processing is labeled "Manual Mode" with a sequential number. Manual processing start and stop times appear in the lower part of the Job box. Details about the processed material appears in the "Material in Job" box on the right.

Identifying and resolving alarms

Cortex posts *alerts* (alarms) to notify operators of problems. The following are examples of events that can cause alerts:

- A process parameter is not in compliance beyond the timeout period
- A component such as a pump or RF generator reports a fault
- A facility supply (water, compressed air, nitrogen etc.) goes off
- An error occurs in the Cortex software
- An operator aborts a process or other system task
- An anomaly such as a material sensing error occurs during a transfer

How Cortex displays alerts

Cortex uses two types of alerts: *warnings*, which have yellow indicators, and *alarms*, which have red indicators. Both types can be referred to as "alarms."

Alerts are displayed in the following ways:

- Status bar:** The Alarm box displays the alert description with a red or yellow background.
- Alarm History screen:** The Type column displays "Alarm" or "Warning" to identify alerts.
- Active Alarms screen:** The "Severity" column displays yellow and red triangle icons to indicate the alert type.
- Alarms button:** The button in the Navigation panel alternates between red and gray shading when a red alert (alarm) is active.

A

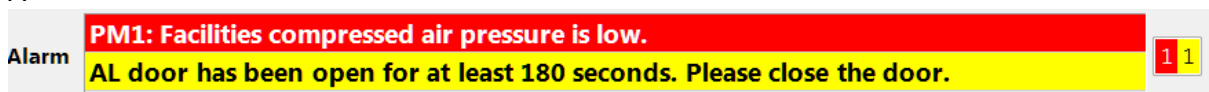

A) The Alarm box with a description of two alerts.

B) The **Alarms** button shaded red when an alarm is active.

All previous alarms and warnings can be displayed on the [Alarm History screen](#). The screen lists alert times, descriptions, and the resolutions that were chosen.

The behavior of the signal tower and alarm buzzer depend on the system configuration and the Signal Tower tool settings.





Responding to warnings and alarms

When alerts are posted, an operator usually has to choose a resolution option. This section describes how to resolve alarms in general. The following section describes what happens when alerts occur during processing.

To respond to active alerts

When an alarm is active, do one of the following:

- Click in the Alarm box in the Status bar.
- Click the **Alarms** menu button and the **Active Alarms** screen button.
- On the Active Alarms screen, you can silence the alert buzzer by clicking **Silence Alarm**.

Time	Severity	Id	Description
2012-09-21 11:40:12.608		PM1	Chamber mech pump is not on, cannot pump down.
2012-09-21 11:39:27.361		PM1	Process interrupted: Turbo pump is not ready. Job: 'O2 Clean', Step: 3 'Light' @ 0:00.0
2012-09-21 11:39:27.290		PM1	Turbo pump is not ready.
2012-09-21 11:39:21.302		PM1	Chamber mech pump should be on.

The Active Alarms screen lists alerts that have not been resolved.

Choosing resolution options

If Active Alarms screen lists more than one alert, click one alert to select it. The lower part of the screen displays resolution options for the selected alert. The resolution options can include the following:

- Acknowledge:** This option is displayed when the alert is not critical and no system is disabled. Clicking **Acknowledge** clears the alarm from the Active Alarms screen.
- Specific actions:** If the alarm was triggered because a requested action could be unsafe, or different conditions are required before continuing, the resolution options can include specific actions. For example, if an operator chose to vent the chamber, but previous actions did not purge the chamber, Cortex warns of the possible presence of process

gases in the chamber, and the resolution options include "Do not vent," and "Pump down chamber."

- Continue Monitoring:** This option keeps the alarm active, and Cortex keeps watching the component or condition that triggered the alarm. For example, if an electrical problem causes the gas subsystem to appear to be disabled, monitoring can continue to see if the system resumes normal operation. If the problem is fixed and the gas system is enabled, the alarm is cleared from the Active Alarms screen, and the resolution is logged as "Auto-Cleared."
- Temporarily Stop Monitoring:** This response clears the alarm from the Active Alarms screen, and ignores temporarily the condition that triggered the alarm.
- Cancel:** The option to cancel is available when an operation cannot be completed. It clears the active alarm and terminates the current operation.

Resolving alerts during processing

If a certain problems happen while processing is active, Cortex posts alerts and interrupts processing, which includes the following actions:

- Stopping gas flow and RF power.
- Pumping down the process chamber (throttle valve fully open).
- Maintaining temperature channels at the recipe setpoints.
- The Start Job status says "Interrupted" with a yellow background.

Choosing resolutions for interrupted processing

When an alert interrupts processing, the Active Alarms screen displays several resolution options. Click the option to use.

Abort Processing: This ends the process job immediately. The effect is the same as clicking the **Abort Job** button on the Start Job screen, or the **Abort** button in the Status bar.

Continue Step: If the cause of the alarm condition can be corrected and processing can continue, this tells Cortex to resume processing at the point of interruption.

Restart Process and Continue Step: This restarts processing at the recipe's "Initial" step. Then Cortex runs the first recipe step that is designated as a "Restart" step, and continues with subsequent "Restart" steps, and then the interrupted step and the rest of the recipe. The process timer resumes at the step where processing was interrupted. For example, if an alarm is posted during Step 6 in a recipe, and "Restart Process and Continue Step" is chosen, the system runs the Initial Step, then any "Restart" steps, and then returns to Step 6 and continues.

Identifying Restart steps



On the [Edit Recipe](#) screen, a circular arrow identifies Restart steps. Click the **Restart Step** button to mark Restart steps in recipes.

In the Jobs box on the [Job History](#) screen, steps in a recipe that are tagged as "Restart" steps are identified by "(Restarting)" in the Events list. A yellow lamp icon identifies jobs that were completed after being restarted.

Creating charts with process data

Cortex provides two ways to create charts with process data:

- The [Charting](#) screen can plot process parameters in real time during processing.
- The [View Datalog](#) screen can create charts from completed process jobs.

Both screens allow selection of parameters, variable chart time periods, and other display options.

For real-time charting: Click **Process** and **Charting**. The graph on the [Charting](#) screen displays up to four parameters while processing is active.

For post-process charting: Click **Data Log**. The graph on the [View Datalog](#) screen displays up to six parameters from saved process data. The screen provides controls for zooming and panning, showing data points and steps, and displaying data values. Data can be exported to CSV files for analysis outside of Cortex.

Plotting live process data

Cortex captures data continually when processing is active. On the Charting screen, you can plot data in real time. You can include up to four parameters, and display from one minute to four hours of data.

Note: To plot data from completed process jobs, use the [View Datalog screen](#).

Cortex assigns a color to each process parameter on a chart. The parameter labels above the chart, and the parameter plot lines, use the same colors, as shown in the following illustrations.

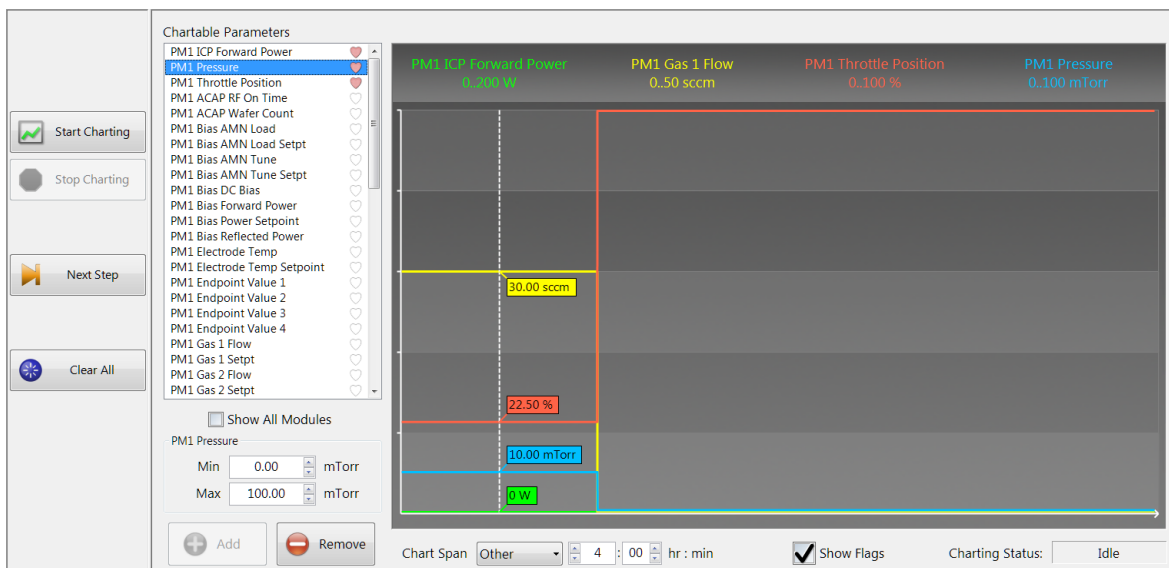

Four parameters can be plotted at once on the Charting screen.



The color of the parameter labels correspond to the plot lines on chart.

To create charts with live data

1. Click **Process** and **Charting** to go to the Charting screen.
2. If parameters are assigned to the chart, and processing is active, parameter data is plotted automatically. If necessary, click **Start Charting** in the left panel to begin plotting the selected parameters.

3. You can add up to four parameter plots to the graph. Do any of the following to add and replace parameters on the chart:
 - To add and remove parameters from the chart, select a parameter in the Chartable Parameters box and click **Add** or **Remove**, or double-click the parameter.
 - To remove a parameter, double-click the label above the chart, or click the label and then click **Remove**, or right-click the label and choose **Remove**.
 - To remove all parameters from the chart, click **Clear All** in the left panel.
4. To change the chart time span, select from the Chart Span menu below the chart. For other display options, see the "Customizing charts" section, below.
5. If a process recipe is running, you can advance immediately to the next step by clicking **Next Step**.

Customizing charts

The following sections describe how to customize charts on the Charting screen.

Displaying step markers

The *Show Flags* option can identify where processing starts and ends, and where recipe steps each start. When the *Show Flags* check box is checked, step lines and labels, and a line at the end of processing, appear on the chart.

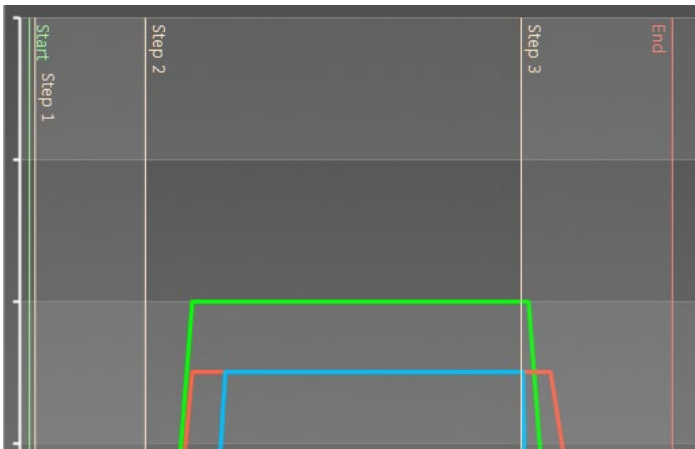

"Show Flags" displays Start, End and Step markers on charts.

Setting the scale for parameter data

PM1 Gas 1 Flow		
Min	<input type="text" value="0.00"/>	sccm
Max	<input type="text" value="100.00"/>	sccm

The *Min* and *Max* boxes below the Chartable Parameters list determine the chart scale for the selected parameter's data.

Click a parameter name above the chart, then enter minimum and maximum values for the chart scale. For example, to set the Gas 1 Flow scale for a 50 sccm flow controller, you can enter 0 and 50 to use the full height of the chart. If you enter 0 and 100, maximum flow (50 sccm) will be plotted in the middle of the chart vertically.

Setting the chart time span

The Chart Span menu has choices for the time period represented on the chart. Click the menu and choose one of the fixed time periods, or choose *Other*, and then enter a time period in the boxes, from 1 minute to 4 hours.



Clearing and redisplaying data

Charts are not erased when processing ends or you click **Stop Charting**. You can leave the Charting screen and return to it to review the data.

The chart is cleared when a new processing session starts.

To clear a chart: Click **Clear All**. The effect of clearing the graph depends on whether new data has replaced the plotted data.

Cortex retains parameter data from the most recent processing session in memory. Removing plotted data from the graph, by clicking **Clear All** or removing parameters individually, does not remove the data from memory. Parameter data can be plotted until a new processing session clears the chart data. You can use the [Data Log](#) screen to create charts from any completed processing session, which Cortex automatically saves.

Selecting 'favorite' parameters

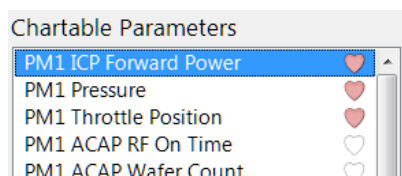

You can designate "favorite" parameters so they appear first in the Chartable Parameters box. To mark favorites, click the 'heart' symbol to the right of the parameters' names. Selected symbols are shaded red.

The parameter order does not change until you go to another screen in Cortex. The next time you go to the Charting screen, the favorite parameters will be at the top of the Chartable Parameters list.

Creating charts of saved process data

The **View Datalog** screen creates charts of process and system parameters plotted over time. Charts can include up to six parameters at once, from process and system data.

A chart can display an entire process duration or a selected time period. You can zoom in and out, pan the chart, and display parameter values at any point in time. The View Datalog screen can also be used to [export process data](#) to a comma-separated values (CSV) data file.

To use the charting feature, click the **Data Log** menu button, which displays the **View Datalog** screen. The logged-in user account must have unlocked security tags for the Data Log menu and View Datalog screen to be able to access these. Cortex automatically logs all process jobs to disk.

Note: To plot process parameters on the View Datalog screen, processing must be completed. Manual processing sessions and processing jobs do not appear in the Select Data Source dialog box while processing is active. However, you can use the Ad Hoc plotting feature to plot any data in the current data buffer, or use the [Charting screen](#) to plot data in real time during processing.

Chart features

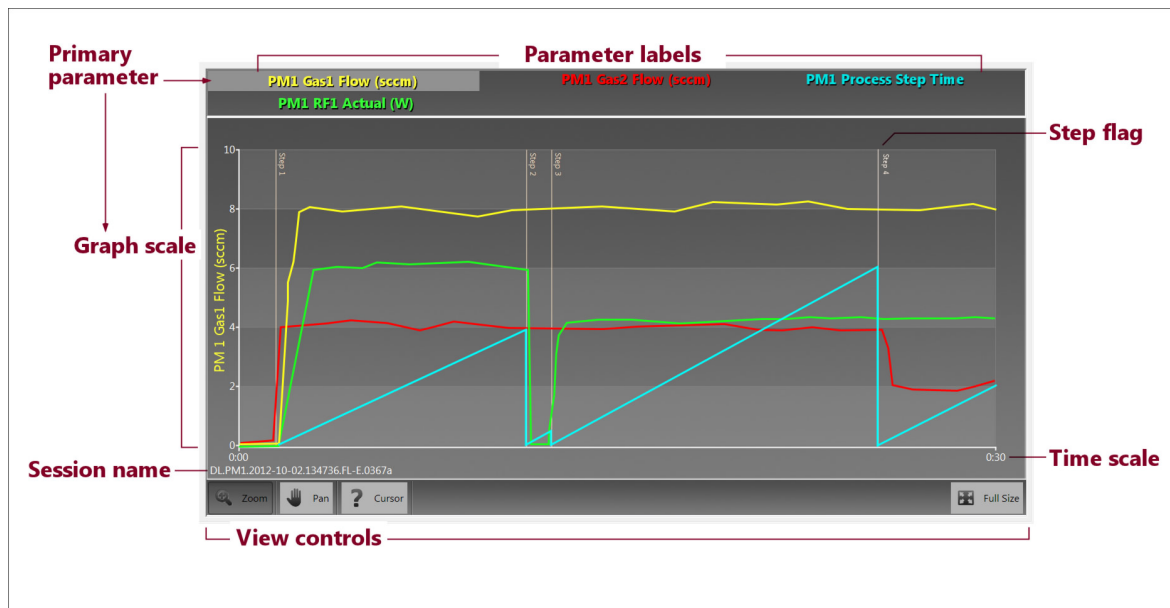

Main chart features on the View Datalog screen. Five parameters are plotted on the chart.

Creating data charts

On the View Datalog screen, you can plot parameters from a selected dataset. Use the following procedure to specify the dataset and the parameters to plot:

1. **Select data:** On the View Datalog screen, click **Select Data**. A dialog box opens for selecting a data file. Select an item in the Log Files list and then click **Load**.
2. **Select parameters:** When you load a data set (or click the **Select Parameters** command button), the Select Plot Parameters dialog box appears. Double-click a parameter in the "Available" list to add it to the "On Chart" list. To add multiple parameters, hold down CTRL and click each item, and then click **Add**. Up to six parameters can be added to the "On Chart" box.
3. Click **OK** to plot the parameters that are in the "On Chart" list.

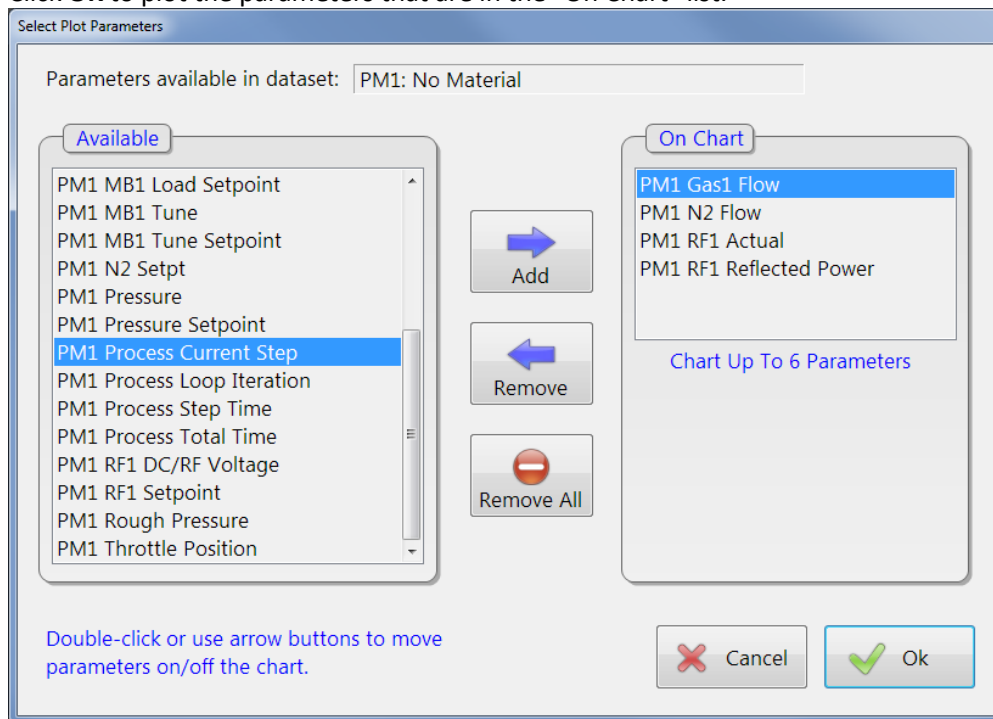

*A selected parameter in the "Available" is added to the chart by clicking **Add**.*

Creating 'ad hoc' charts from system data

Recent system data, from processing and non-processing time periods, can be plotted on the View Datalog screen. The "ad hoc" chart feature allows system parameters to be reviewed to pinpoint anomalies that may occur when the system is not processing.

Cortex continuously stores the system data in a buffer. The oldest data is replaced as newer data is added to the buffer. The buffer holds data from the previous several hours, up to 24

hours. The amount depends on the number of parameters, the data sampling rate, and available system memory.

To plot recent system data

1. On the View Datalog screen, click **Select Ad Hoc** in the left panel.
2. A dialog box appears. Drag the sliders to set the Start and End times for the chart data. The Beginning and Ending boxes show the earliest and latest data that is available. The Selected Range box shows the start and end times that are set by the sliders.

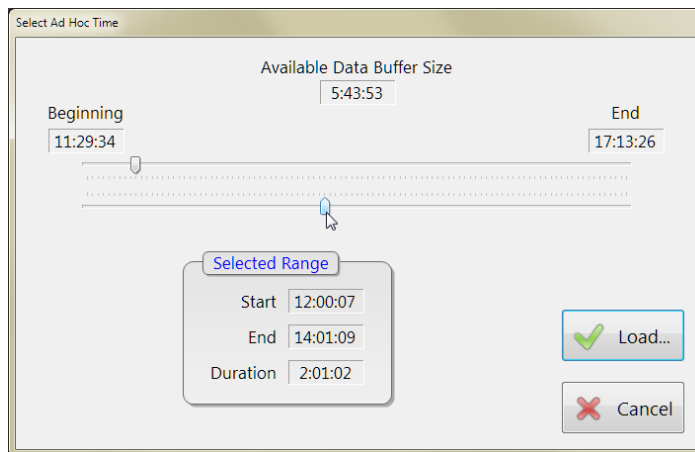

3. Click **Load** to continue.
4. The Select Plot Parameters dialog box (pictured above) appears. Select the parameters to include on the chart (as described in the previous procedure "Creating data charts").
5. Click **OK** to create the chart with the selected parameters.

Charts are labeled "Ad Hoc" with the start and end times.

Note: By default, the "Select Ad Hoc" button is not available for any user account. To make the feature available, its security tag must be unlocked for the logged-in user.

Customizing charts

You can change the parameters on the chart, zoom in and out, and select other options for the chart display.

Setting the primary parameter

The chart is labeled with the plotted parameter names in two rows above the chart. The parameter label colors match the plot lines. A shaded bar indicates the *primary parameter*; the

vertical scale of the chart (the y axis) is based on the values of the primary parameter. Click a parameter label to make it the primary parameter.



Parameters labels above a chart. The shaded bar indicates that "PM1 Gas1 Flow" is the primary parameter.

Adding, removing, and replacing parameters

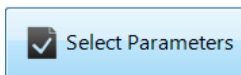

Do one of the following to add, remove, or replace parameters on the chart:

Click the **Select Parameters** command button and use the dialog box to change the parameters on the chart (see Step 2, "Select Parameters," above).

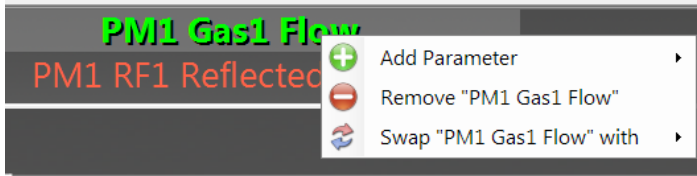

Right-click a parameter name above the chart. A menu pops up; do one of the following to specify parameters:

- Choose from the **Add Parameter** > submenu to add a parameter.
- Choose from the **Swap [parameter] With** > submenu to replace the parameter with another one.
- Choose **Remove [parameter]** to remove the parameter.

Zooming, scrolling, and displaying values

When a data set has been loaded (see above) on the View Datalog screen, the chart shows the entire process duration by default.

To zoom and scroll the display

Do any of the following to change the area displayed on the chart:

- To magnify a part of the chart, click **Zoom**. The cursor changes to a magnifying glass. Drag a box on the chart to enlarge the area inside the box.
- To return to the previous magnification level, right-click on the chart and choose **Undo Last Zoom**.

- To show the entire chart, right-click and choose **Full size**, or click the **Full Size** button below the chart. This sets magnification so the full process duration is shown.
- To shift the chart view without changing magnification, click **Pan**. The pointer changes to a hand. Drag the chart in any direction. The chart moves in the direction you drag (unless the chart is already full size).

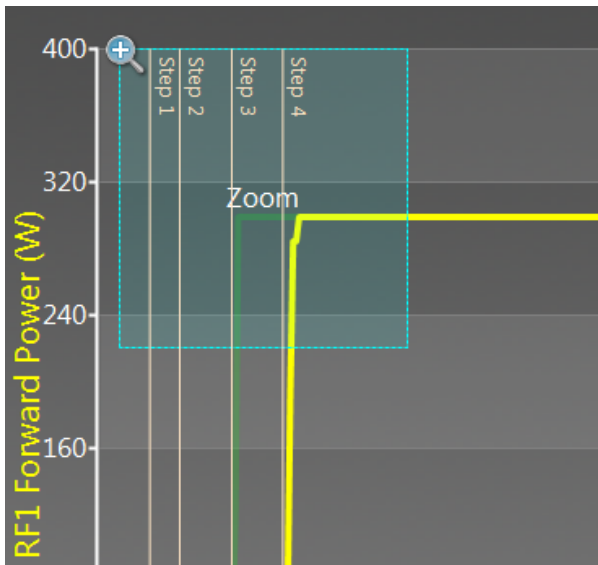

A shaded box indicates the area to be magnified when using the Zoom button.

To show steps, data points, and values

Recipe steps can be indicated by vertical lines and labels, and numeric values of plotted parameters can be displayed on the chart.

- Click **Cursor** to display data values. When the Cursor option is active, the pointer is a hand with a question mark. Hold down the mouse button with the pointer on the chart to display parameter values at the pointer position.
- Values are colored the same as the parameter plot lines. The exact pointer position is indicated by a dashed vertical line; the time within the current step and the time within the overall process appear above the chart at the pointer position (see diagram below).
- Click the **Show Flags / Hide Flags** command button to show or hide vertical lines and labels that mark the start of each recipe step.
- Click the **Show Markers / Hide Markers** command button to toggle the display of individual data sample points on the plot lines. Data sample points appear as small black dots, and typically are visible when the chart spans less than about two minutes. When the chart encompasses longer time periods, the individual data points are typically not visible.



Using the Cursor feature: Parameter values at 2.0 seconds after the start of Step 4 (1:04.0 after process start). BCI3 flow (green) is 15 sccm; RF1 Forward Power (yellow) is 114.8 watts; pressure (red) is 15.00 mTorr.

Displaying the alarms history

Cortex saves all warnings and alarms (referred to together as *alerts*) that occur on the system. The Alarm History screen displays a listing of the saved alerts. To display the alarm history screen, click **Alarms** and **Alarm History** in the Navigation panel.

A table on the Alarm History screen includes a description, which is text that appeared in the Alarm box when the alarm occurred. The table also shows the time and cause of each alert. The table displays the following additional information:

Type of alert: The Type column identifies each entry as an "Alarm" or "Warning." These correspond to the red (alarm) and yellow (warning) colors used in the Alarm box in the Status bar.

How alarms were resolved: The Resolution column lists the response that was selected for each alert. The same information appears in the Information column on the Job History screen.

When an alert is selected in the table, additional details appear in the Details box on the Alarm History screen (shown below). This includes the logged-in user at the time of the alert and its resolution, and the component involved.

Details	
Description	Alarm: Stopped by user Cycle test aborted.
Posted	2019-09-30 11:36:05.702 (User: Lab)
Component	System
Resolved	2019-09-30 11:36:12.649 (User: Lab)
Resolution	Acknowledge

The Details box shows more information about the selected alert.

Sorting and filtering the alarm list

Changing the sort order or category

By default, alarms are listed in chronological order, with the earliest alarm first. To reverse the sort order, click the "Time" column heading.

Click any column heading to sort on that heading. An arrow indicates the sort order, either up (ascending) or down (descending).

Filtering by date or keywords

To limit the number of items shown in the list, use the options in the Filter box. Text at the top of the box shows the number of alerts displayed (based on the Filter settings) and the total number of alerts.

Date and keyword filtering are both applied to produce the alarm listing. To filter by keywords only, click the **All** button to remove date filtering. To filter by date only, if there is text in the Keyword box, select the text and press the DELETE key to clear the box.

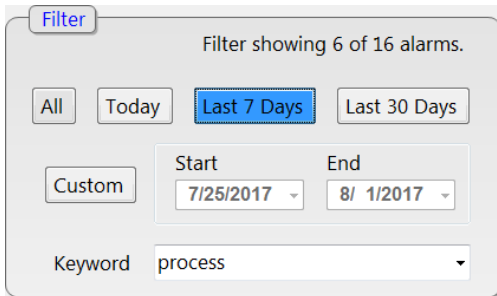

The Filter box can show alerts based on time periods and keywords.

Filtering by date

- Click **Today**, **Last 7 Days**, or **Last 30 Days** to display just the alarms from the current system date, the last week, or the last 30 days.
- Click **All** to remove date filtering.
- To enter an arbitrary range of dates to display, click **Custom** and enter dates in the Start and End boxes. Type a date in the form *month/day/year*, or click the arrow and click in the calendar that appears to specify the date. When a date range button is selected, the Start and End date boxes display the specific dates used to filter the list.

Filtering by keywords

To show only items containing specific text, type the text in the Keyword box and press the TAB or ENTER key. Only records that contain the specified text in any field (Time, Type, Description, or Resolution) will appear.

Partial words: You can enter parts of words as well as numbers in the Keyword box. For example, if you enter "temp," all records containing the word "temperature" are displayed. If you enter the letter "w," all records containing "Warning" in the type column, and records that contain a "w" in any other column, are displayed.

Combined filtering: You can use both date and keyword filtering to limit which entries are displayed.

Previous keywords: Press the arrow at the right end of the Keyword box to select from previous Keyword entries.

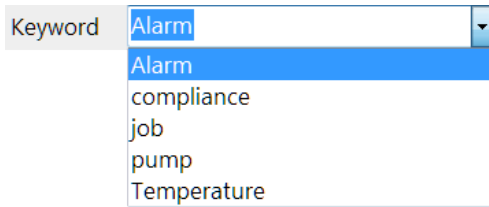

The Keyword menu lists previously entered keywords.

Setting the maximum alarm history size

The listing on the Alarm History screen is created from a disk file that stores all alarm information. The oldest alarms are regularly removed from the file to prevent it from consuming an unlimited amount of disk space. The number of previous alarms that are saved can be changed by a user who has sufficient access authority.

The tool setting "Max Alarm Log Size" determines the maximum number of alarms that are kept in the alarm history file. The default value is 300 alarms. The minimum is 10 and the maximum is 1,000. The file on disk consumes roughly 30 KB for 100 alarms.

The tool setting is located in the System/logging section on the Tool Settings screen.

Viewing job information and system data

Cortex saves data from process jobs, and saves information about resource usage and system access. It creates various log files to store this information. For long-term archiving, log files can be copied and saved outside the system. Cortex can create a package (zip file) of current log files; these packages can be archived, and can be sent by email for technical support.

This topic discusses ways of viewing and working with saved data and log files, and settings that affect log files.

For information about creating charts with process data, see the the [Charting](#) and [View Datalog](#) topics.

See [About Cortex](#) for information about all the Cortex log files and diagnostic files that are saved on the system disk.

Location of the Logs folder

Log files are stored in the "Logs" folder. Its location is set by the path in the *Data Log Folder* box on the System tab of the System Configuration screen. The default location is in the Cortex program folder.

To set the Logs folder location

1. Click **System > Configuration**, then select the *System* tab on the System Configuration screen.
2. The current Logs folder location is shown in the Data Log Folder box. To change the location, do either:
 - Type the new path to use in the text box.
 - To use the default path, click **Reset to Default**. This puts the default path in the text box.
3. To save a new path, click **Save Config**. A confirmation message appears. Click **Restart** to restart Cortex. Cortex must be restarted to use a new path.

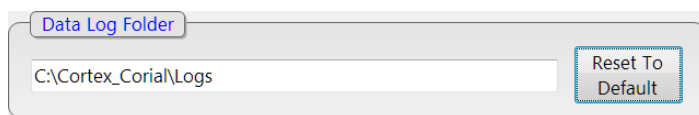

The Logs folder path on the System Configuration screen.

Packaging log files

To provide technical help, customer support staff may ask for the system's log files. Cortex can copy the system's data logs and configuration files into a ZIP file, a compressed package file. This file can be sent by email or other means to technical support personnel.

To create a package of log files

1. Click **Diagnostics > Debug Log** to go to the Debug Log screen.
2. Click the **Package Logs** button. Cortex creates a ZIP file on the computer desktop. The file is named "Cortex Debug" followed by the system name and the extension ".zip."

Viewing job history information

Cortex records a variety of information about every job, including regular [process jobs](#), [manual processing sessions](#), and [ACAP jobs](#).

The screenshot displays the Cortex software interface with two main panels. The left panel, titled 'Jobs', contains a table listing job details. The right panel, titled 'Material in job: InGaAlAs Cl2_H2 180c', contains a table listing material details. Below each table is an 'Events' section for the selected job and material.

Time	Job Id	User
2012-09-19 16:23:20	InGaAlAs Cl2_H2 180c	Administrator
2012-09-19 16:08:00	O2 Clean	Administrator
2012-09-19 15:46:26	ACAP on PM1	Administrator
2012-09-19 15:45:05	GLP_Process-52EX	Administrator
2012-09-18 17:37:54	ACAP on PM1	Administrator
2012-09-17 18:09:00	ACAP on PM1	Administrator
2012-09-17 18:08:10	ACAP on PM1	Administrator
2012-09-17 18:07:12	ACAP on PM1	Administrator
2012-09-17 18:06:14	ACAP on PM1	Administrator
2012-09-17 18:05:17	ACAP on PM1	Administrator
2012-09-17 18:04:20	ACAP on PM1	Administrator

Events during job: InGaAlAs Cl2_H2 180c

Time	Information
2012-09-19 16:23:20	Job started.
2012-09-19 16:23:21	Transfer [InGaAlAs Cl2_H2 180c]: AL-Arm => PM1-Electrode.
2012-09-19 16:23:35	Run process 'InGaAlAs Cl2_H2 180c-Engineering' on [InGaAlAs Cl2_...

Material Id	Status
InGaAlAs Cl2_H2 180c	Active

Events on material: InGaAlAs Cl2_H2 180c

Time	Information
2012-09-19 16:23:36	PM1 process 'InGaAlAs Cl2_H2 180c' started.
2012-09-19 16:23:52	Initial Step #1 has begun.
2012-09-19 16:23:57	Chuck Step #2 has begun.
2012-09-19 16:23:58	Process Step #3 has begun.
2012-09-19 16:24:08	Process Step #4 has begun.

Jobs are listed in the top-left table. Information about the selected job appears in the other tables.

To view job information

1. Click **Process > Job History**.
2. Select a job in the *Jobs* box to view the job's events, steps, and material.
3. Select an item in the *Material in Job* box to see all events for that material (wafer).
4. Select the *Show ACAP* option to display all jobs. Otherwise, ACAP jobs are not listed.

The Job History screen is updated regularly. During processing individual steps and status changes are posted to the log. Before a job is finished, a yellow circle in the status column indicates an incomplete job; the status indicator changes to green when the job is complete.

Job history information is stored in a file named *Job History.db* in the *Logs* folder on the system computer. By default, the system saves 31 days of job history information. This duration is a [Tool Setting](#) named *Job History Purge Time* under *Logging*. The setting can be from 1 day to 365 days.

Individual jobs information



The upper table in the *Jobs* box lists each job. The box title shows the total number of jobs displayed.

To sort the jobs list, click on a column heading label (Time, Job ID, Recipes, or User). The default sort order is chronological.

When a job is selected in the jobs list, additional information (described below) appears on the Job History screen.

Each row in the Jobs table displays the following information for one job:

Job Status: The first column shows status by color:

-  Job completed (no anomaly).
-  Job incomplete (executing).
-  Job aborted before completion.

Job ID: The column displays a Job ID or other information, depending on the job type:

- Regular jobs have the text entered in the *Job ID* box. If no ID was entered, the recipe name appears for regular and on-demand jobs.
- ACAP jobs have "ACAP on PM" with the module number.
- Manual processing sessions have "PMx Manual Mode *n*," where *x* is the module number and *n* is a sequential number.

Recipes: The column lists the recipe(s) used in the job. If all text isn't shown, hover on the table cell to show it.

User: The user who was logged in to Cortex when the job was executed.

Job events information

The lower table in the *Jobs* box lists *Events During Job* for the job that is selected in the upper table:

Time: This column shows the date and time (24-hour format) of all job events.

Information: The *Information* column describes each event. Events that are listed are job started, material transfers, processing, and job finished.

Material information and events

Information about the material in the job that is selected in the *Jobs* box appears in two tables in the *Material in Job* box on the right:

The upper table lists each piece of material in the job. It shows the material ID, a status light, and a description.

Note: On Load Lock (non-cassette) systems, material is not identified. The "Material in Job..." box lists "No Material" in the Material ID column for all jobs.

The status shown in the material list indicates the material's "historical" status, not the current wafer status. The following are the possible indicator colors and status labels:

Color	Status label
-------	--------------

	Pending, Active, or Completed With Issues.
---	--

	Completed
---	-----------

	Aborted
---	---------

Note: Material status colors on the Job History screen can differ from the status indicators on the cassette diagrams (*Start Job* screen and others). For example, the cassette diagram does use yellow when a wafer is being processed.

"Completed with issues" refers to a wafer that finished processing, but had one or more unusual events during processing. Examples of unusual events are the following:

- An alarm occurred while processing.
- A recipe was restarted.
- A step was skipped.

Material events

The box at the lower right of the main panel shows times and information for the material that is selected in the upper table.

Time: The Time column shows the date and the time (in 24-hour format) for each material processing event.

Information: The column describes each event that occurred for the selected piece of material. This includes the start and end of processing, and the start of each process step. It identifies steps by name or type (Initial, Process, Chuck, Temperature, etc.) and number.

Viewing system usage data (gas, wafers, RF, ACAP)

The **Resource Usage** screen displays the amount of process gas used, the RF generator-on time, the number of wafers processed on the system, and details about **Auto Clean and Prep** (ACAP) operations. Totals accumulate until the values are reset.

To display the resource usage information, click the **Service** menu button and the **Usage** screen button. The Usage screen can be displayed only if the logged-in user account has unlocked **security tags** for the Service Menu and Usage screen.

The screenshot displays the Resource Usage screen with four data panels:

- Gas Usage:** A table with columns: Gas, Liters, Last Reset, and a Reset button.

Gas	Liters	Last Reset	Reset
Gas 1	103.66	09/03/2019 13:31:53	Reset
Gas 2	26.43	09/03/2019 13:31:53	Reset
Gas 3	37.02	09/03/2019 13:31:53	Reset
Gas 4	0.40	09/03/2019 13:31:53	Reset
Gas 5	0.00	09/03/2019 13:31:53	Reset
Gas 6	18.77	09/03/2019 13:31:53	Reset
Gas 7	0.00	09/03/2019 13:31:53	Reset
Gas 8	0.00	09/03/2019 13:31:53	Reset
- RF On-Time:** A table with columns: On-Time, kW-hr, Last Reset, and a Reset button.

	On-Time	kW-hr	Last Reset	Reset
Bias	5.04	0.62	09/03/2019 13:31:53	Reset
ICP	5.04	1.40	09/03/2019 13:31:53	Reset
- Wafer Count:** A table with columns: # Wafers, Wafers/day, Last Reset, and a Reset button.

# Wafers	Wafers/day	Last Reset	Reset
29	0.57	09/03/2019 13:31:53	Reset
- Automated Clean & Prep:** A table with columns: Metric, Value, Last Reset, and a Reset button.

		Last Reset	Reset
Wafer Count	29	09/03/2019 13:31:53	Reset
Job Count	11	09/03/2019 13:31:53	Reset
RF On Time (hrs)	1.64	09/03/2019 13:31:53	Reset
Film Thickness (µm)	0.00	09/03/2019 13:31:53	Reset
Day Count	3710188.2	09/11/2019 17:04:00	Reset

The Resource Usage screen displays gas usage, RF on-time, wafer count, and Auto Clean & Prep data.

Gas Usage: The Gas Usage box displays the system's gas channels, the amount used (in liters), and the date and time the usage data was last reset.

RF On-Time: The RF On-Time box displays the system generator(s), the generator use time, the total power applied (in kilowatt hours), and the date and time the usage data was last reset.

Wafer Count: The Wafer Count box shows the number of wafers that have been processed, the number of wafers processed per day, and the date and time the usage data was reset.

Resetting usage data

Data on the Resource Usage screen is locked to prevent accidental changes. To reset any of the usage data, click **Unlock Reset Buttons**, then click the **Reset** button at the right of the usage data. The usage data is reset to zero and the Last Reset date changes to the current date and time.

Resource usage data is independent of the processed jobs log file. While the job log file increases in size as more jobs are run, and older jobs are eventually purged from the log, the Wafer Count on the Resource Usage screen always consumes the same, very small amount of disk space, and has no purge schedule. All "odometer" data on the Resource Usage screen accumulates unless it is reset by a user clicking the Reset buttons.

Viewing the user login history

The User Log screen shows the most recent user log-in and log-out actions recorded by the system. The screen displays the user account name in the first column. The Login and Logout columns display the date (in month-day-year format) and the time (in 12-hour format) that the user logged in and logged out, with the length of time the user was logged in to the system shown in the last column.

If no log out time and duration data are shown, the user did not log out before the system was shut down. If another user logs in, the system shows the original user logging out at the same time the new user logs in.

User Name	Login	Logout	Duration
Administrator	8/29/2012 1:41:43 PM	8/29/2012 1:42:19 PM	0:36
Administrator	8/29/2012 1:49:06 PM	8/29/2012 2:03:57 PM	14:51
MikeT	8/29/2012 2:03:57 PM	8/29/2012 2:04:21 PM	0:24
Administrator	8/29/2012 2:04:21 PM	8/29/2012 2:05:59 PM	1:37
Operator	8/29/2012 2:05:59 PM	8/29/2012 2:06:35 PM	0:35
Administrator	8/29/2012 2:06:35 PM		
Administrator	8/29/2012 2:11:27 PM		
Administrator	8/29/2012 2:13:34 PM	8/29/2012 2:14:56 PM	1:21
Operator	8/29/2012 2:14:56 PM	8/29/2012 2:15:18 PM	0:21
Administrator	8/29/2012 2:15:18 PM	8/29/2012 2:17:03 PM	1:45
Operator	8/29/2012 2:17:03 PM	8/29/2012 2:18:01 PM	0:57
Engineering	8/29/2012 2:18:01 PM	8/29/2012 2:44:37 PM	26:35
Administrator	8/29/2012 2:44:37 PM		
Administrator	8/29/2012 4:57:22 PM		
Administrator	9/4/2012 11:17:08 AM		
Administrator	9/4/2012 2:22:53 PM		
Administrator	9/4/2012 5:23:41 PM	9/4/2012 5:24:28 PM	0:46
NanC	9/4/2012 5:24:29 PM	9/4/2012 5:24:39 PM	0:10
JoeB	9/4/2012 5:24:39 PM	9/4/2012 5:24:54 PM	0:15
RonG	9/4/2012 5:24:54 PM	9/4/2012 5:25:08 PM	0:13
Shift1	9/4/2012 5:25:08 PM	9/4/2012 5:56:10 PM	31:02
Administrator	9/4/2012 5:56:10 PM		
Administrator	9/5/2012 9:23:11 AM		
MikeT	9/6/2012 11:24:37 AM		
Locked	9/6/2012 11:44:27 AM	9/6/2012 11:47:41 AM	3:14

The User Log screen shows when users were logged-in.

User history file and purge setting

The log file that stores user login information is named "User Log.xml" and is stored in the Logs folder in the Cortex program folder on the system computer hard disk. By default, the system saves 30 days of user information.

The length before the log is cleared can be changed on the **Tool Settings** screen by selecting "Logging: User Log Purge Time." The minimum setting is 1 day and the maximum is 365 days.

Exporting process data

You can export process data from Cortex to comma-separated values (CSV) format. CSV is a text-based format that can be opened by spreadsheet applications such as Microsoft Excel and Google Sheets.

The **Export to CSV** command button is available on the View Datalog screen after you select data to display. You can select jobs stored in memory and in log files. Data for all logged parameters can be exported.

To export process data

1. On the View Datalog screen, click **Select Data**.
2. In the Select Data Source dialog box, select a log file, and then click **Load**.
3. The Select Plot Parameters dialog box appears. Select the parameters to include in the exported file, and then click **OK**.
4. Click **Export to CSV**.
5. A dialog box appears showing the selected parameters, which are highlighted. Do any of the following to add or remove parameters:
 - You can click **Select All** or **Deselect All** under either the Typical Parameters and Extended Parameters lists.
 - To select multiple parameters, hold down CTRL and click each parameter to select or deselect it.
6. You enter a new name for the exported file in the Filename box. Click **Export** to create the data file.

A message lists the file name and location. If a file with the same name has already been exported, a message asks whether to overwrite the existing file; click **Yes** to save the new file.

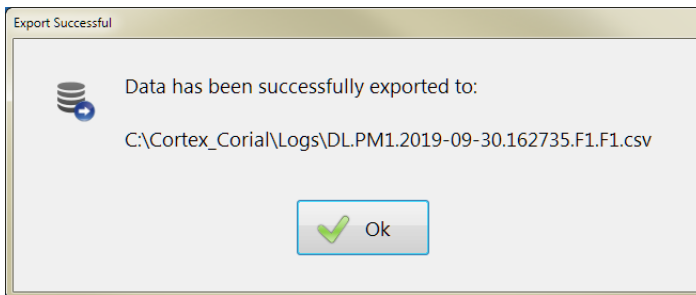

A message shows the location and name of the exported file.

About exported process data



In an exported CSV file, each data value is enclosed in double quote marks, and there is a comma separating the values. The first line of the file consists of the parameter names and measurement units. The first value in each row is the time, in decimal minutes, that elapsed since the start of the process; time values are not enclosed in quote marks.

	A	B	C	D	E	F	G	H	I	J	K	L	M	N
1	Time	PM1 ACAF	PM1 ACAF	PM1 Bias	PM1 Bias	PM1 Bias	PM1 Bias	PM1 Bias	PM1 Bias	PM1 Bias	PM1 Bias	PM1 Chan	PM1 Chan	PM1 Elect
2	0	1.574	17	0	0	0	0	0	0	0	0	20	20	20
3	0.5	1.574	17	0	0	0	0	0	0	0	0	20	20	20
4	1	1.574	17	0	0	0	0	0	0	0	0	20	20	20
5	1.5	1.574	17	0	0	0	0	0	0	0	0	20	20	20
6	2	1.574	17	0	0	0	0	0	0	0	0	20	20	20
7	2.5	1.574	17	0	0	0	0	0	0	0	0	20	20	20
8	3	1.574	17	0	0	0	0	0	0	0	0	20	20	20
9	3.5	1.574	17	0	0	0	0	0	0	0	0	20	20	20
10	4	1.574	17	0	0	0	0	0	0	0	0	20	20	20
11	4.5	1.574	17	0	0	0	0	0	0	0	0	20	20	20
12	5	1.574	17	0	0	0	0	0	0	0	0	20	20	20
13	5.501	1.574	17	0	0	0	0	0	0	0	0	20	20	20
14	6.001	1.574	17	0	0	0	0	0	0	0	0	20	20	20
15	6.501	1.574	17	0	0	0	0	0	0	0	0	20	20	20
16	7.001	1.574	17	0	0	0	0	0	0	0	0	20	20	20
17	7.501	1.574	17	0	0	0	0	0	0	0	0	20	20	20
18	8.001	1.574	17	0	0	0	0	0	0	0	0	20	20	20
19	8.501	1.574	17	0	0	0	0	0	0	0	0	20	20	20
20	9.001	1.574	17	0	0	0	0	0	0	0	0	20	20	20
21	9.501	1.574	17	0	0	0	0	0	0	0	0	20	20	20
22	10.001	1.574	17	0	0	0	0	0	0	0	0	20	20	20
23	10.501	1.574	17	0	0	0	0	0	0	0	0	20	20	20
24	11.001	1.574	17	0	0	0	0	0	0	0	0	20	20	20
25	11.501	1.574	17	0	0	0	0	0	0	0	0	20	20	20

Cortex exported data opened in a spreadsheet.

Vacuum leak testing

Testing the system's ability to maintain vacuum is a recommended daily maintenance activity. Use the **Leak Test** screen to run leak tests on the process chamber, load lock, and gas channels. The screen provides real-time pressure data and shows previous test results.

To display the Leak Test screen, click **Service > Leak Test**. The *Screen: Leak Test* security tag must be unlocked for the logged-in [user account](#).

To perform leak testing

1. Set the [system focus](#) to AL to test the load lock, or PM1 to test the process chamber or gas lines.
2. On the Leak Test screen, the *Handler* option is selected if the focus is on the AL module. If the focus is on the process chamber, select an option:
 - To test the process chamber: Select *Chamber*.
 - To test the gas distribution system, select *Gas Manifold*.
 - To test an individual gas channel: Select *Gas Channel*, then select the channel from the drop-down list.
3. Select an option in the Test Duration box:
 - Select "Until Stopped" to run the test continuously until **Stop** is clicked.
 - Select "Fixed Duration" and enter the duration (*hours: minutes: seconds*). The maximum duration is 23:59:59.

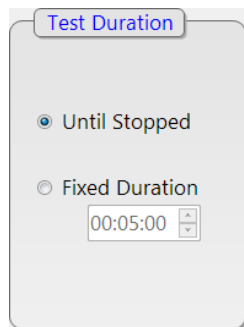

4. Click **Leak Test** to start testing. Cortex establishes a base pressure, then displays pressure change and calculated leak rate per minute. The Status box shows the system activity during the test.

The screenshot shows a control panel for a leak test. At the top left, there is a tab labeled "Leak Test". Below it, there are two radio buttons: "PM1 Chamber" (selected) and "Gas Channel" (with a dropdown menu showing "1) O2"). To the right of these is a "Status" field with a green bar and the text "Leak Test". Below the radio buttons is an "Elapsed Time" field showing "00:00:22". In the center, there are three input fields: "Pressure" (50.6 mT), "Starting Pressure" (50.2 mT), and "Change" (0.4 mT). At the bottom right, there is a "PM1 Leak Rate" field showing "1.200 mTorr/Min".

The Leak Test box shows current and starting pressure, pressure change, elapsed time, status, and leak rate.

Viewing leak testing data

The following information appears in the Leak Test box during and after testing:

Pressure: The current pressure as measured in the chamber being tested. All pressure measurements use the unit of measure selected in the system configuration.

Starting Pressure: The pressure that was measured when the test began.

Change: The difference between the current pressure and the starting pressure.

Elapsed Time shows the amount of time (*hours: minutes: seconds*) since the pressure was stabilized and the leak test began.

Status displays "Isolating Pump Train" and then "Stabilizing Base Pressure" if the system is pumping the chamber. "Leak Test" appears when the elapsed time counter starts and the test is running.

Leak Rate: Cortex calculates leak rates by dividing the pressure change by the elapsed time. The value remains on screen and is added to the Historical Leak Tests table.

Previous leak test data

The *Historical Leak Tests* table lists the most recent leak tests, with the test date, module, base pressure, leak rate, test duration, and temperature.

To add a note: Click in the Notes field and type any text. Press Enter when you finish. If the text is longer than the box can show, hover over the box with the pointer to display the complete note.

Leak test data can be copied from the table using the system Clipboard functions. Click in the table to select a row, or drag across the table to select multiple test records. Press CTRL+C to copy the selected data to the Clipboard. Open a document (such as a text document or spreadsheet) in another application, and then press CTRL+V to paste the copied data.

Historical PM1 Chamber Leak Tests						
Test Date	Base Pressure	Leak Rate	Unit	Duration	Temperature	Notes
8/1/2017 5:53 PM	5.0x10 ⁻² T	-0.015	mTorr/Min	06:31:42	80,30°C	Run after regular maintenance
7/26/2017 11:46 AM	5.0x10 ⁻² T	1.183	mTorr/Min	01:02:06	20,20°C	Run before regular maintenance
7/25/2017 4:41 PM	5.0x10 ⁻² T	1.187	mTorr/Min	00:01:34	20,20°C	Tested following process run

Vacuum system service controls

The Vacuum System screen provides direct access to the vacuum system. To display the Vacuum System screen, click the **Service** menu button and the **Vacuum System** screen button.

Users with the necessary [security settings](#) can control individual vacuum components, after enabling controls (as described next). Users can also initiate pumping and venting, isolate a chamber, and stop the vacuum system, as described under "Changing the vacuum system state."

Note: By default, the Operator account does not have access to the Vacuum System screen.

Unlocking the vacuum controls

The Vacuum System screen is locked to prevent accidental changes. Users cannot toggle valves or use control buttons unless the controls are enabled. A square sign in the main panel (shown below) displays a lock symbol when controls are disabled. A blinking warning icon appears when controls are enabled.

To enable vacuum controls

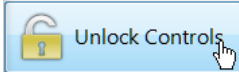

Click **Unlock Controls** in the left panel. The "Controls Disabled" sign changes to "Controls Enabled."

The controls get locked anytime another screen is displayed, including if the main panel is switched from the PM1 to the AL vacuum system by changing the [system focus](#).

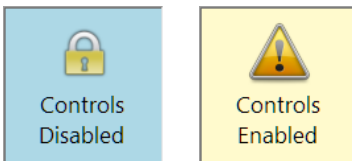

Status of vacuum system controls: "Disabled" (locked) or available "Enabled" (available).

Note: If the security tag for the "Unlock Controls" button is itself locked, the logged-in user cannot unlock the vacuum controls.

The vacuum startup state and starting the pumps

The state of the vacuum system when Cortex starts depends on configuration settings, which are described here.

Settings that affect the startup state

On the System Configuration screen, Handler tab, the "Startup State" setting can be one of the following, with the described results:

Do Nothing: When Cortex starts, the AL and PM1 will be in "Unknown" state. Pumps do not start automatically. This is the default configuration. See the procedures below for starting pumps and establishing vacuum.

Always pump down: Cortex starts the Mech pump and pumps AL to base pressure.

Permanent Atmosphere: The load lock is vented, if necessary, to be at atmosphere with the lid open when Cortex starts.

To start the mechanical pump

With the system focus on either module, click **Pump Down** in the left panel.

Note: A configuration setting determines whether there are separate mechanical pumps for each module. When the "Mech Pump" option is selected, on the Handler tab, a separate pump is configured for the load lock (AL). Otherwise, both chambers share the system Mech pump.

To start the turbo pump

With the system focus on PM1, click **Pump Down**. Or, Click the **Start** button in the Turbo Pump box in the main panel ("Controls Enabled" must be displayed). When **Pump Down** is used, Cortex also opens the High Vacuum valve.

The Turbo Purge valve is opened only when process gas is flowing.

Changing the vacuum system state

The context buttons in the left panel can be used to change the vacuum system state. The buttons — **Pump Down, Vent, Isolate, Shutdown** — are enabled if their actions can be applied. They appear gray if they are not available. For example, during the venting procedure, only the Abort button is available.

Note: On Corial load lock systems, the process chamber is vented through the load lock. Therefore, if the system focus is on PM1 when the Vent button is used, both the load lock and the process chamber will be vented. If the system focus is on the load lock, only the load chamber will be vented.

The effects of the vacuum context buttons are described next.

Pump Down

This button initiates pumping down to base pressure of the chamber that has the [system focus](#). "Pump down complete" appears in the Info box when base pressure is achieved, and the vacuum system state is then "Pumping idle."

If necessary, Cortex does the following when initiating pump down:

- AL: Starts the mechanical pump if necessary, opens the Rough valve. The info box displays "Lock pumpdown complete" at base pressure, and the Rough valve closes.
- PM1: Cortex starts the mechanical pump and turbo pump, if necessary, opens the throttle valve, High Vacuum, Foreline, and activates the Chamber pressure gauge.

Vent

This button starts venting the chamber that has the system focus. On Corial load lock systems, both chambers are vented when the PM is vented, or only the load lock (AL) chamber is vented.

- AL venting: While venting, the Vent valve on the load lock is open. When complete, the system state is "Vented." On the system diagram, the AL chamber is shaded light blue.
- PM1 venting: The load lock chamber is pumped down, then the slit valve is opened, and both chambers are vented. The High Vacuum valve is closed. The Turbo Purge valve (if open) is closed. The throttle valve remains open. The turbo and mechanical pumps remain operating.

Isolate

This button closes off the chamber that has focus from the vacuum system.

- When PM1 has focus, Cortex closes the High Vacuum valve and deactivates the Chamber pressure gauge.
- When AL has focus, the Rough Valve is closed.

Shutdown

The Shutdown button isolates the chamber that has focus.

- When PM1 has focus, isolation de-activates the Chamber gauge. It closes the High Vacuum valve and Rough valve. The turbo pump is turned off (the Turbo Purge valve is closed if it was open). The throttle valve remains at its current position. Cortex does not stop the Mech pump.
- When AL has focus, isolation closes the Rough valve, if it was open. It does not stop the Mech pump.

Abort

The Abort buttons stops any operation that is in progress. The Abort button is available when a vacuum operation, such as venting or pumping down, is underway. Aborting a process that caused the turbo pump to start does not turn off the turbo pump.

Vacuum screen diagrams and controls

The main panel of the Vacuum System screen shows the components of the load lock (AL) or process module (PM1) vacuum system, depending on the [system focus](#).

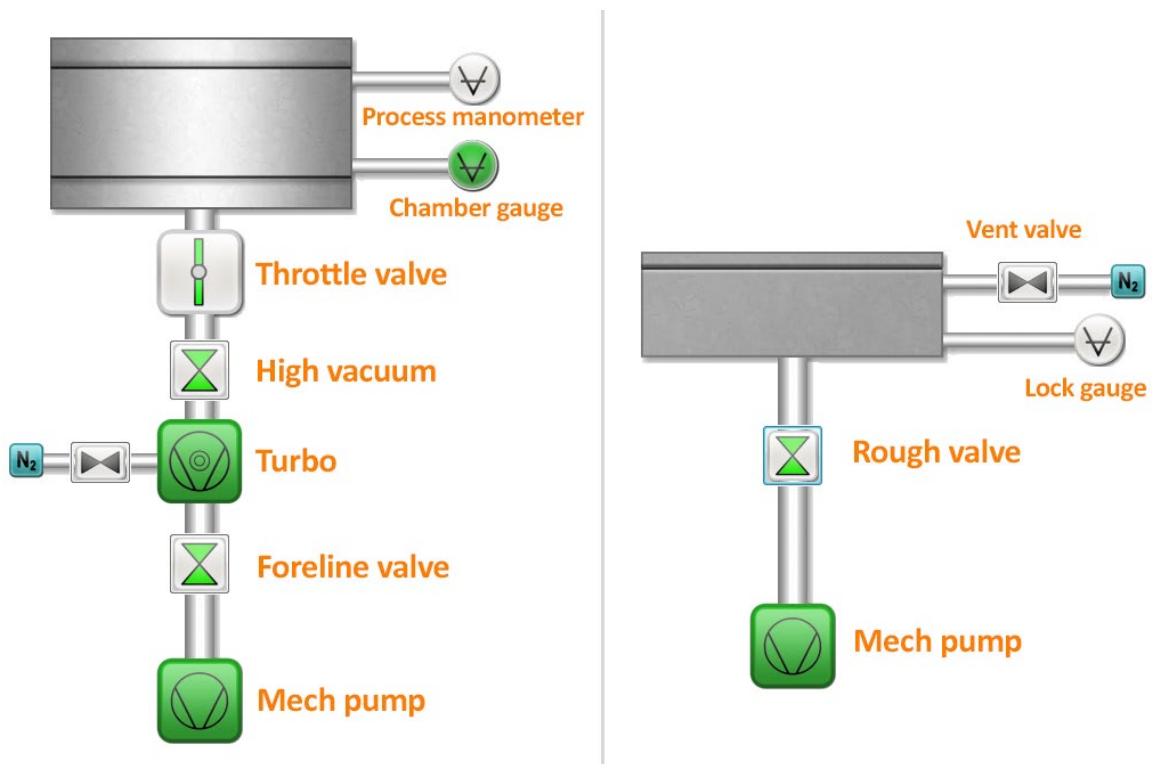

The PM1 (left) and AL (right) vacuum diagrams show the status of pumps, valves, and gauges.

Vacuum component diagrams

The diagrams depicting the vacuum system include the following:

- Status indicators:** Color shading of pumps, switches, valves, and chambers indicate their status. Green indicates open valves and operating pumps. Gray indicates closed valves and pumps that are off.
- Pressure values:** The current pressure reported by each gauge is displayed next to the gauge symbol.
- Control buttons:** Buttons on the vacuum diagrams can be used to operate the throttle valve, load lock lid, and the turbo pump.

Operating valves

Clicking a valve on the vacuum system diagram switches its current state to open or closed. Cortex prevents unsafe changes, such as opening a valve that would expose the turbo pump to pressure above the turbo limit.

System state labels

The State box on the Vacuum System screen describes current activity and the state of the PM or AL chamber:

- Unknown:** The chamber state is not determined, before the chamber has been pumped down. This is the default state when Cortex starts.
- Isolating, Isolated:** The chamber is isolated from the vacuum system.
- Pumping Down:** The chamber is being pumped down to base pressure.
- Pumping Idle:** Pumping continues after the chamber achieves a specified pressure level.
- Venting, Vented:** The chamber is being vented to atmosphere, "Vented" appears when atmosphere is reached.

Gas system service and maintenance

The Gas System screen can be used to monitor gas channels and directly control the gas system. The screen contains a diagram of all configured gas channels. Authorized users can control gas valves, enter gas flow setpoints, and monitor actual gas flow and valve positions.

To display the Gas System screen, click the **Service** menu button and the **Gas System** screen button. The [system focus](#) must be on the process module.

The Gas Maintenance screen can be used for evacuating and flushing gas valves. Those procedures are described after the Gas System screen operations, below.

Note: The Gas System and Gas Maintenance screens are not intended for use by operators. By default, the "Operator" user account does not have access to any screens in the **Service** menu.

Using the gas system diagram

The Gas System screen shows the layout of the system's gas box and gas channels. It includes gas source lines, mass flow controllers (MFCs), purge/flush lines, and lines leading to the process chamber and the pump (exhaust).

The following information and components are included in the diagram (see labeled illustration, below):

- Gas lines are shown as gray tubes. Gas sources are to the left (not shown). The manifold that all gas lines are connected to is on the right.
- MFCs appear as gray boxes that are labeled with gas names and maximum flow capacity. Each MFC includes Setpoint and Flow boxes. The Flow box shows the current gas flow for each channel. Note that the Setpoint box does not show gas flow setpoints from process recipes or values that have been entered on other screens, including Manual Mode.
- The position of gas channel valves is indicated by colored shading, as described below.
- Each channel has an isolation valve before the MFC and a process valve after the MFC. Each pair of valves is connected to one pneumatic control line, and therefore they close and open together.

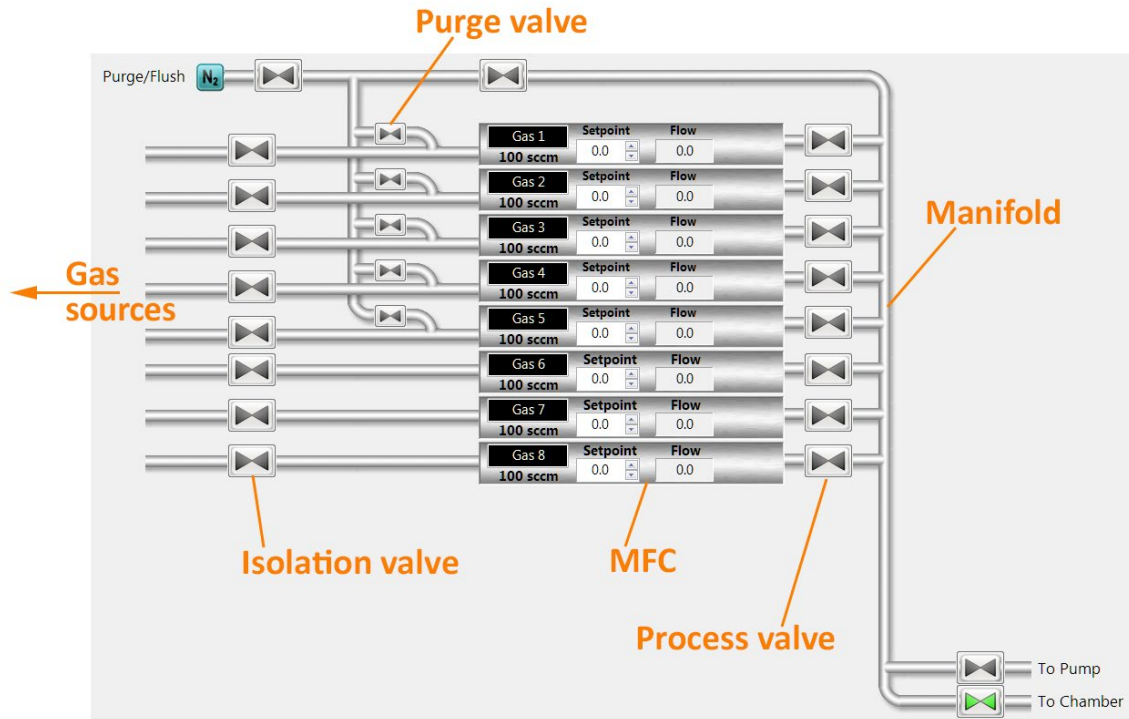

The Gas System diagram displays valves, setpoints, and flow rates.

Valve symbols and states

On the gas system diagram, the color of a valve symbol indicates the valve position:

Symbol	Color	Valve state
	Gray	Closed
	Green	Open
	Red	Flow inhibited

Note: Cortex inhibits flow if the chamber pressure is above the process limit, or if gas is flowing in a channel that is part of a forbidden pair. In some cases gas valves are not red, even though they cannot be operated, such as when a hardware interlock is preventing gas flow.

Operating gas channels

Valves can be operated and gas setpoints changed on the Gas System screen (if allowed by the logged-in user's account settings). The following procedure starts and stops gas flow. Additional information about setpoints and valve operation follows the procedure.

To start and stop gas flow

1. On the Gas System screen, click **Unlock Controls** to enable operation of gas channels. The status box says "Controls Enabled" with a blinking warning icon when the controls are unlocked.
2. Type the flow setpoint in the Setpoint box of the gas channel and then press ENTER.
3. Click the Process or Isolation valve symbol (see diagram, above) to activate the valves. Both valves turn green when they open. The Flow box shows the actual flow amount, which should increase until reaching compliance with the setpoint, when it changes from yellow to green.
4. Gas flow continues until one of the following occurs:
 - Flow setpoint is set to zero.
 - Gas channel valves are closed.
 - The **All Gas Off** button is clicked. This sets all flow setpoints to zero and closes the valves on all gas channels.

Unlocking screen controls

By default, the Gas System screen is locked, so that gas controls can't be operated accidentally. Before operating valves or changing setpoints, click **Unlock Controls**. The button is not available if its security tag is locked for the logged-in user.

Opening and closing gas valves

Click a valve on the Gas System screen to toggle the valve position. An open valve is green; a closed valve is gray. On each gas channel in the Corial 210IL gas box, the isolation valve and process valve are linked; both valves open or close when either one is opened or closed.

Working with setpoints and gas flow

A gas flow setpoint can be changed by typing in the Setpoint box and pressing TAB or ENTER. The value can also be increased or decreased by clicking the arrow buttons or pressing the Up or Down arrow keys.

The Flow boxes indicate if gas is flowing and is in compliance with the setpoint. When gas is not flowing, the Flow box is gray. If the box is yellow, gas is flowing but is not in the tolerance range of the setpoint. When gas flow is in compliance with the setpoint, the Flow box is green.

Stopping gas operations: Click the **All Gas Off** button to stop all gas flow. Cortex closes all valves in the gas box and sets flow setpoints to zero.

Evacuating and flushing gas lines

Cortex can evacuate and purge gas lines for service and maintenance. These actions are available on the Gas Maintenance screen. Click **Service > Gas Maint** to go to the Gas Maintenance screen. Set the system focus to the process module (PM1) to use the Gas Maintenance screen.

The Gas Maintenance screen is available only to user accounts that have their security configured for access to the Service menu button and the Gas Maint screen button.

To evacuate gas lines

The evacuation process empties a gas line of residual gas by pumping the entire line from the source shutoff valve. You select which lines to evacuate.

Important: Before beginning evacuation of gas lines, you must manually close the supply valve on each gas source (gas bottle) for the lines to be evacuated. If gas sources are not closed off completely, gas will be pumped through the system until the supply is completely depleted.

1. Click **Service > Gas Maint**. The Gas Maintenance screen appears. Set the focus to PM1 if necessary.
2. Select the gas lines to evacuate by clicking the "Select" boxes. A check mark indicates channels to be evacuated. If one gas channel of a forbidden pair is selected, you cannot select the other gas channel's checkbox.
3. Click **Evacuate Gas Lines**. Cortex pumps down the chamber.
4. A message warns that that manual gas valve for the channel to be evacuated must be closed. Click **OK** to continue.
5. Cortex sets the flow setpoint to maximum and opens the channel's valves, so that the entire line is pumped out. The chart on the Gas Maintenance screen shows the flow rate through the MFC as the channel is pumped out.
6. When flow decreases to zero, Cortex closes the channel's valves.
7. For each selected gas channel, Cortex repeats steps 4, 5, and 6.
8. When all channels have been evacuated, Cortex reopens the valves on all the selected channels, sets the flow setpoints to maximum, and continues pumping. To end the evacuation process, click **Stop**. Cortex closes all valves and changes setpoints to zero.

To flush gas lines

Flushing is similar to evacuating gas lines. The difference is that inert purge gas (N₂) flows through a gas channel when it is being flushed.

Important: The user must manually close the supply valve on each gas source (gas bottle) before beginning to flush gas lines. If gas sources are not closed off completely, gas will be pumped through the system until the supply is completely depleted.

1. Click **Service > Gas Maint.** The Gas Maintenance screen appears.
2. Select the gas lines to flush by clicking their "Select" boxes. A check mark indicates channels to be flushed. If one gas channel of a forbidden pair is selected, you cannot select the other gas channel's checkbox.
3. Click **Flush MFCs.** A reminder to close the gas source valve appears. Click **OK** to continue.
4. Cortex sets the setpoint on the first selected gas line to the MFC's maximum value, and opens the Isolation and Process valves. Note that the setpoint value does not appear on the Gas Maintenance screen.
5. When flow through the MFC has decreased to zero, Cortex opens the Purge valve for the gas line. Pumping continues with purge gas flowing for one minute by default (see "Setting the purge duration," below). Cortex then closes the Purge valve.
6. If there are additional selected gas channels, Cortex repeats the previous two steps for each channel.
7. When all channels have been flushed, Cortex closes all gas system valves.



The Purge valve, MFC, and both valves on the process gas line are open when a gas channel is being flushed.

Setting the purge duration

A tool setting specifies the duration of the purge process. To set the value, select "Gas Flush Duration" under "PM1/Maintenance" on the Tool Settings screen. The default setting is 60 seconds, with a minimum of 10 seconds and maximum of 999 seconds.

Cathode lift and helium cooling controls

The Mechanism screen provides status information and operating controls for the electrode lift and helium cooling.

To use the Mechanism screen, click the **Service** menu button and the **Mechanism** screen button.

Operating the cathode lift

The process module is equipped with a mechanism that raises and lowers the electrode, referred to as the *cathode* on ICP systems. The cathode is a circular platform that holds a material carrier. Raising the cathode places material that is on the carrier in contact with the material clamp.

For troubleshooting and maintenance, the mechanism can be operated independently using the Cathode Lift tab of the Mechanism screen. This tab is available only when the [system focus](#) is on the process module (PM1).

The two boxes on the Cathode Lift tab contain status indicators and buttons to operate the mechanism.

Moving the cathode: The **Go To Top** and **Go To Bottom** buttons initiate movement of the cathode. When the electrode is raised to the top position, the material carrier is raised and makes contact with the clamp ring.

Electrode position status: The indicator lights in the Status box show the cathode position:

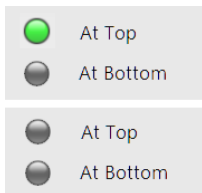

- When "At Top" is green, the cathode is in the raised position, with the material carrier in contact with the clamp.
- When "At Bottom" is green, the electrode is at its lowest position.
- If both indicators are gray, the position of the clamp is not determined.

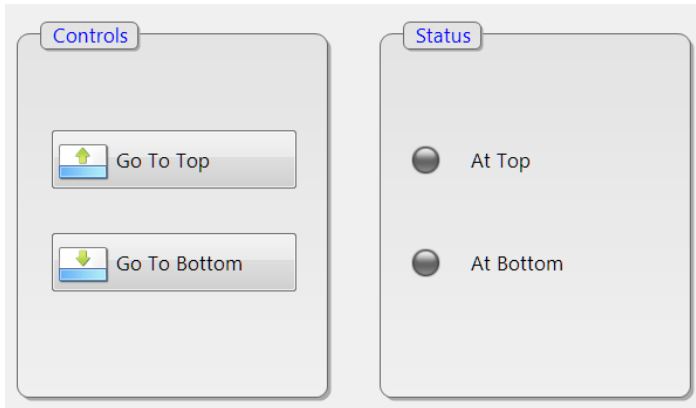

Cathode controls and status indicators are on the Cathode Lift tab.

Note: Cathode controls are also on the **Handler > Teach** screen.

Cathode I/O signals

Control and status signals for the process module mechanism are shown on the "Mech" tab of the I/O screen:

- **Control signals:** The "Clamp Go Up" and "Clamp Go Down" digital output signals are the control signals that Cortex sends to raise and lower the mechanism, respectively.
- **Status signals:** The status of the mechanism is shown by the digital input signals "Clamp is Up" and "Clamp is Down."

Cathode lift timeout setting

The timeout for cathode movement is set by the Cathode Timeout value on the Tool Settings screen. This setting is at PM1/Cathode. The default value is 10 seconds.

Operating the helium circuit

The Chuck Cooling/Clamping tab contains setpoints and controls for testing backside helium cooling.

On Corial ICP systems, the material graphite carrier has perforations that allow helium to flow into the area under a wafer.

The maximum pressure allowed in the helium circuit is 60 Torr. If the pressure exceeds this limit, the system goes into safety shutdown mode.

To operate helium cooling

1. Select the Pressure or the Flow option. This setting determines which setpoint is used.
2. Enter the setpoint for the selected control option (Pressure or Flow). The setpoints are specified in mTorr (pressure) or sccm (flow).
3. Click **Start** to begin flowing helium at the specified setpoint. The Actual box shows the helium flow or pressure value. The box is green when the helium flow or pressure is in compliance with the setpoint, or yellow if the actual value is not in compliance.
4. The button label is "Stop" when helium is flowing. Click **Stop** to turn off backside helium.

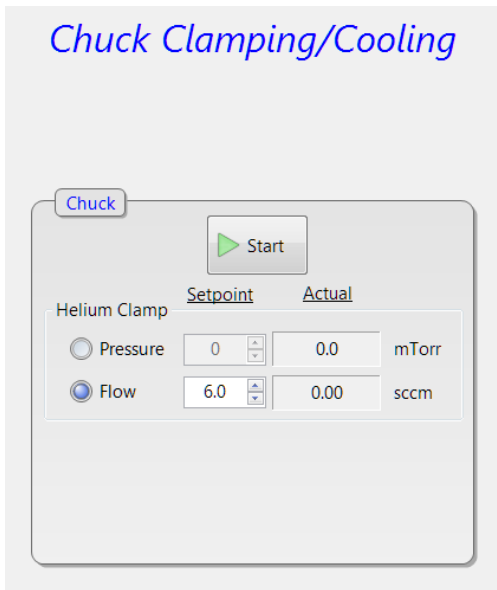

Setpoints and status indicators on the Chuck Cooling/Clamping tab.

Helium settings and I/O signals

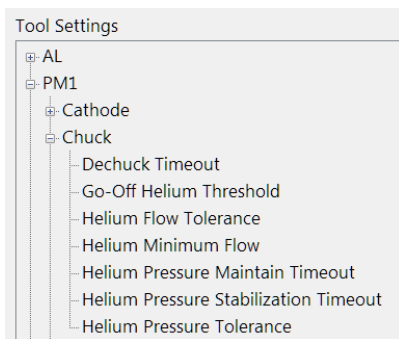

Several settings affect helium cooling, including the compliance timeout period, which by default is 120 seconds.

On the Tool Settings screen, helium settings are at PM1/Chuck. The settings include dechucking timeouts, helium stabilization and pressure timeouts, minimum helium flow, and the default flow tolerance.

The two timeout settings apply to helium cooling at different stages of the Chuck step in recipes:

- "Helium Pressure Stabilization Timeout" applies to the beginning of the Chuck step. When helium flow starts, Cortex waits for helium pressure or flow to stabilize before continuing. The default timeout value for this stabilization period is 45 seconds.
- After helium stabilization, the setting "Helium Pressure Maintain Timeout" specifies the maximum amount of time that helium flow or pressure can be out of compliance before Cortex posts an alarm. The default value is 5 seconds.

Control and status signals

On the I/O screen, status and control signals for helium cooling are on the Mech panel. The panel displays the following signals:

•Analog outputs

Helium Clamping Setpoint and *Helium Flow Setpoint* are the control signals for helium flow in volume (sccm) and backside pressure (mTorr) units.

•Analog inputs

Helium Flow and *Helium Clamping Pressure* are status signals from the equipment. The values represent the actual flow in volume and pressure units.

•Digital outputs

Open Helium Valve is the control signal for the valve on the helium supply line.

Helium Clamping Regulation is a control signal that determines whether helium backside pressure is being measured for compliance with a pressure setpoint. This signal is active only when the Pressure setpoint is used.

Monitoring I/O signals

The I/O screen provides direct access to Navigator control and sensor signals for valves, manometers, pumps, RF, and other components.

I/O signals can be monitored to verify that system components are operating correctly. Signal values can be **plotted** on a graph. This can be helpful for troubleshooting issues such as intermittent signal loss or unexpected sensor readings.

The I/O screen is available only if the appropriate **security tags** are unlocked for the logged-in **user account**. By default, only the Administrator account has access to the I/O screen.

Many control and sensor signals affect items displayed on other screens, mainly the Process and Service screens. A few signals such as the RF/gas interlock status, are displayed only on the I/O screen.

Three buttons select categories of signals to display on the I/O screen: **Gas/Vacuum**, **RF/Temp**, and **Misc**. A magnifying glass symbol appears on the currently active button.

I/O signal types and values

All I/O signals are either analog or digital, and either input or output signals. Thus there are four labels on the **I/O screen**: Digital Inputs, Digital Outputs, Analog Inputs, and Analog Outputs.

Input signals transmit status information and measurements from devices and sensors to Cortex. For example, the pump's on/off status is a digital input; chamber pressure is an analog input.

Output signals send commands and values from Cortex to system devices. Settings such as temperature and pressure are analog output signals; commands such as "close valve" and "turn on pump" are digital outputs signals.

Analog signals can vary continuously, conveying a range of values. At the hardware level, the voltage of the electrical signal correlates to a value such as a specific temperature or pressure. Cortex can display these values or the actual signal voltages; see "Displaying actual and measured signal values," below.

Digital signals are binary, either on or off (signifying active/inactive or true/false). Digital signals do not carry numeric values such as measurements.

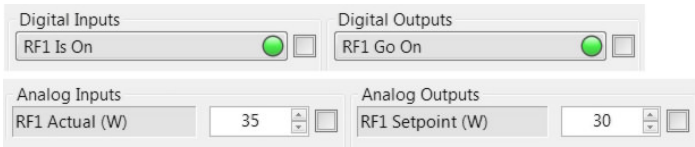

Examples of digital and analog inputs and outputs.

Digital signal indicators

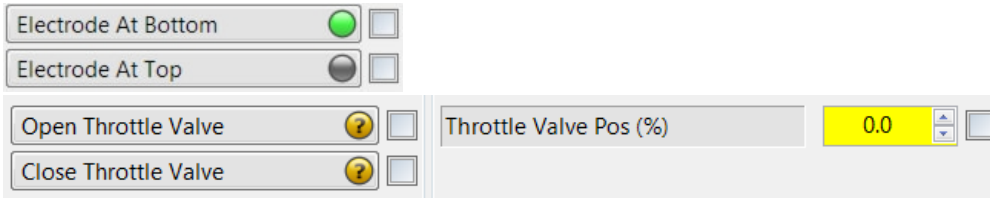

Indicators show the state of digital signals.

Digital signals have indicator "lights" that show their state: Green for on, Gray for off.

For example, the "Throttle is closed" digital input signal is green when the throttle valve is fully closed (0% open). It is gray if the throttle valve is 1% to 100% open. The "Close Throttle Valve" digital output signal is green when Cortex sends a signal to close the valve, and is gray when Cortex is not sending the signal to close.

Yellow indicators appear when signals are not available before communication is established at startup, or when communication is interrupted. A series of yellow lights appearing during regular operation can indicate that a controller block is not working.

A yellow circle and question mark or yellow background indicate loss of communication.

Analog signal values

Analog signals do not have indicator lights; they display numeric values, such as pressure setpoints and pressure readings. The unit of measurement is part of the signal label, such as "Process Gauge Pressure (mT)" expressed in millitorr, and "Throttle Position Setpoint (%)" expressed as a percentage.

The value boxes turn yellow if an analog signal's communication is not valid.

Displaying actual or measured values

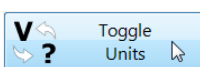

Analog signal values can be displayed as actual voltages or as the corresponding measurements.

To switch the display, click **Toggle Units** in the left panel of the I/O screen. Clicking the button changes the display of all analog signals in all categories.

Raw Units shows actual signal voltages. Viewing signals in raw units can help with troubleshooting calibration and connection issues. The signal labels are red when raw units are displayed.

Engineering Units shows values as physical measurements, such as temperature in degrees Celsius and pressure in mTorr.

For example, with Raw Units selected, the value displayed for the RF1 Power Setpoint is the actual voltage sent to the RF generator to specify power output. With Engineering Units selected, the signal value is displayed as the RF power setting in watts. The signal is always a voltage on the wire, but the I/O screen displays the corresponding power value in watts when Engineering Units is selected.

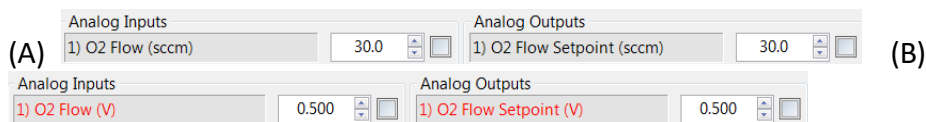

Analog values displayed in Engineering units (A) and in Raw units (B).

Overriding I/O signals



WARNING:

Overriding control signals or sensor values can produce hazardous conditions that could cause serious injury to persons and damage to equipment. Software and hardware interlocks may not prevent hazardous conditions that result from overriding I/O signals. In most cases, other controls include safety interlocks, and therefore should be used for regular operations. Only trained and authorized personnel should be allowed access to the I/O screen.

Input and output signals, both digital and analog, can be overridden. The state of digital signals can be flipped between on and off, and the values of analog signals can be set to new values.

I/O Override

The label "I/O Override" appears in the Status bar whenever any I/O signal is overridden.

Analog signal overrides

Overriding an analog signal requires clicking the check box to enable an override, then typing a new value in the box.

For example, clicking the check box for a gas channel "Flow Setpoint (sccm)" signal, and then typing "50" in the box sets the gas flow to 50 sccm. After typing a value, press Tab or Enter, or click outside the box to set the new value.

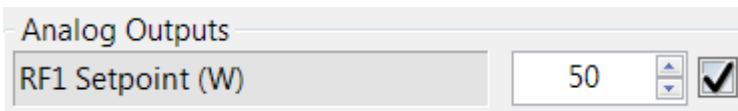

A check mark indicates override of "RF1 Setpoint (W)" with value of 50 W.

Digital signal overrides

Overriding a digital signal requires clicking the check box to enable the signal override, and then clicking the label to switch the state from active to inactive or from inactive to active.

For example, selecting "RF1 Go On" and clicking the label switches the control signal to the RF1 generator. If the signal was inactive, it switches to active and the indicator goes green. If the signal was active, it switches to inactive and the indicator goes gray.

Releasing signal overrides

Overrides on I/O signals can be released by category and on individual signals. Note that when signal overrides are released, each signal (analog or digital) will revert to the state directed by Cortex, which might not be the same as the overridden value.

Do the following to release overrides:

- To cancel all signal overrides in a single category, click the category button and then click **Release Overrides**. If signals in other categories have overrides, the Status bar continues to display the I/O Override indicator. Select each category to display the signals and click **Release Overrides** to cancel overrides in each category.
- To cancel I/O overrides on individual signals, click to clear the check mark.

Displaying I/O signals on graphs

Cortex can display signal values on graphs. The graph boxes on the I/O screen can show the values of three I/O signals over the previous 60 seconds.

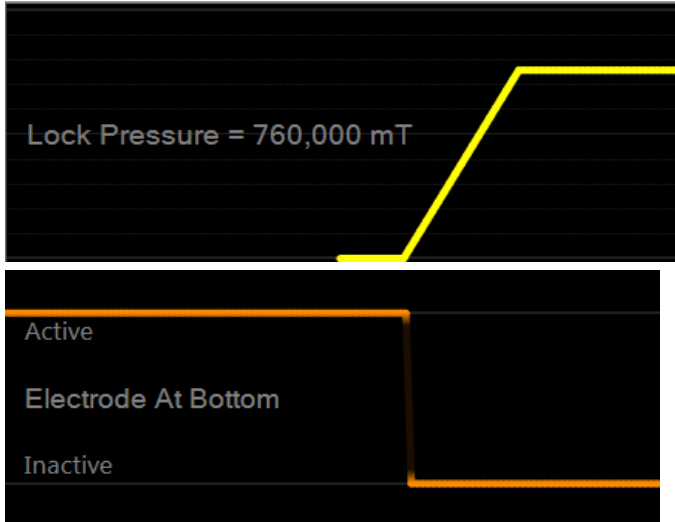

Left: A graph shows an analog signal value rising. Right: A digital signal changes from active to inactive.

To plot signal values

1. Click the **Service** menu and **I/O** screen button to display the I/O Access screen.
2. While holding down the right mouse button, drag the signal label to a graph box. The signal replaces an existing plot if there is one in the box.

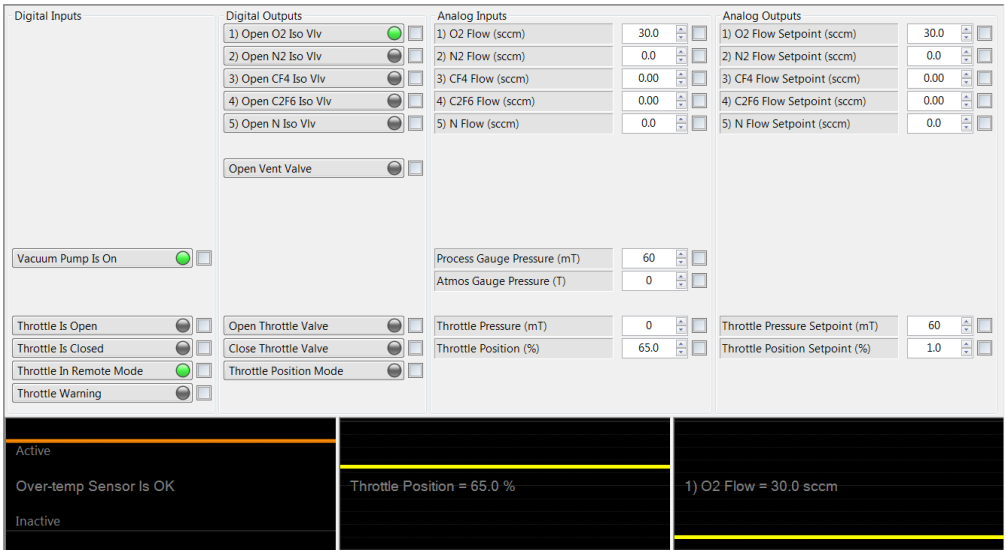

The three graph boxes on the I/O screen can show plots of analog and digital signals.

To reset or clear a graph

Right-click on a graph box and choose a command from the context menu:

- To remove a plotted signal, choose **Remove Signal**.
- To clear the graph and continue plotting the signal, choose **Clear Plot**.

Cortex installation and license keys



The Cortex program runs on a standard industrial computer using Microsoft Windows operating system. The following sections provide details about the Cortex software installation, including the related programs that may be installed, how licensing is verified, and the location of settings and log files. This information is intended to assist service technicians and system administrators with troubleshooting and system maintenance.

About the Cortex program installation

Files that make up the Cortex program are stored in a folder named *Cortex*. This folder is typically on the computer's C: drive. The Cortex software, settings, and saved data including recipes, flows, and log files, can be backed up by copying the entire Cortex folder to another location. It's recommended that backup folders be renamed to something such as "Cortex Backup" to avoid confusion with the program folder.

Note: The location at which Cortex saves its log files can be changed on the System Configuration screen.

Additional software

In addition to Cortex, the system computer contains other programs that support Cortex or provide services for technical support. These can include the following programs and software:

- **Team Viewer.** This is a remote-access program, which technical support can use to view Cortex, transfer files, and perform other actions remotely. A remote connection cannot be established with Team Viewer unless the system has a network connection to the Internet.
- **EndpointWorks.** If the system is equipped with the endpoint detection option, the EndpointWorks program is installed on the system computer, along with additional hardware.
- **Communication software.** On Corial systems, FTP software and the NFS file system protocol are required to communicate with the EC-22 interface module. These are installed on the Cortex computer.
- **.NET framework.** Cortex uses the Microsoft "Dot Net" framework and Microsoft Common Language Runtime (CLR) libraries. Generally, the latest .NET framework is installed with Cortex.

Software license verification

When Cortex starts, it performs licensing verification, which can include checking for hardware devices that authorize use of Cortex and optional software that is installed on the system. These actions are described next.

Cortex security key

Cortex requires a USB security key, which must remain plugged in to the system computer when Cortex is running. If the security key is not plugged in, Cortex displays an alert message. If the security key is not inserted within 30 seconds, Cortex stops running.

The security key for a particular tool cannot be used in any other Plasma-Therm tool. The security key uses Crypto-Box technology, and must be programmed during system manufacture.

SECS/GEM security key

If the system is configured for factory automation (SECS/GEM), Cortex checks for the hardware license key. It displays two alert messages if the key is not found. Cortex will run without the security key, but the factory automation interface will be disabled.

Other software licenses

If the system is configured for additional Plasma-Therm software, including Endpointworks or GLANCE, the same security key that allows Cortex to run is set up with the appropriate license verification codes.

Locations of settings and log files

Files that contain Cortex settings and data are stored in folders inside the Cortex program folder. The following tables list all the files that are in the Cortex subfolders.

Configuration folder files

Files in the Configuration folder store various settings, including user accounts, ACAP rules, factory automation, and system configuration.

File name	Description of file contents
-----------	------------------------------

ACAP Rules.xml	Auto Clean & Prep settings
AL Arm.xml	Robot settings
Configuration.xml	System configuration settings
GEM Interface.xml	Factory automation settings and Cortex-supported messages and VIDs
Menu.xml	Cortex menu and screen settings
Network.xml	Cortex internal network settings
Tool Settings.xml	System operation settings from Tool Settings screen
UI Settings.xml	Cortex interface language and other system settings
Users.xml	Cortex user account settings

Diagnostics folder files

Several types of files that record internal software activity are stored in the Diagnostics folder. Plasma-Therm technical support staff may request these files for troubleshooting problems.

File name	Description of file contents
DebugLog.<Year-Month-Day Timecode>.txt	Cortex internal messages, start/stop of managers and threads, subsystem initialization, file maintenance, etc.
GUILog.<Year-Month-Day Timecode>.log	Record of actions by Cortex users, including logins, commands executed, settings changed. One file is created for each day. Old files are purged according to tool setting. Helps in diagnosis or program and user issues.
Info Log.txt	Cortex informational messages output — all messages that Cortex

displays in the Info box in the Status bar.

Trace Settings.xml Cortex program debugging settings (level of messages to be recorded for Cortex program segments).

Logs folder files

The Logs folder contains the Alarm Log and User Log files, and the job history database.

File name	Description of file contents
Alarm Log.xml	Record of alarm occurrences with time, user, severity, description, and resolution information.
Job History.db	SQLite database containing data for all process jobs and processing sessions.
User Log.xml	Each user login and log out with time and date.

Persistence folder files

Files in the Persistence folder record information about the system's state, material locations, chart default settings, and resource usage data.

File name	Description of file contents
Chart Defaults.xml	Settings for process data charts.
Cycle Test.xml	History of transfer mechanism tests.
Datalog View Defaults.xml	Default settings for View Datalog screen.

Material.xml	Location of material within the system.
PMx Manual Mode Settings.xml	Default settings and setpoints for Manual Mode screen.
Resource Usage.xml	Data on gas consumption, ACAP counters.

Recipe folders

Saved process recipes are stored in subfolders for the process module (*PM_n*) and the recipe category (Engineering, Experimental, Personal, and Production). Recipes are stored individually in XML-format files. From the Recipe Editor screen, you can export recipes to PDF files. Cluster systems also save Flows, which combine recipes with material movement instructions, in the Flows folder inside the Recipe folder.

Help folder files

Files for the Cortex online documentation are stored in the Help folder. The file "default.htm" can be opened to launch the online Help content. To make the documentation available in another location, copy the entire Help folder to preserve links among the topic files. To view the Help in a web browser, open the *default.htm* file.

Language folders

Language-specific files contain translation resources for Cortex. These files are stored in folders named with language and dialect abbreviations, such as "fr-FR" for French. Not all parts of the Cortex interface are translated when an interface language other than English is selected on the Cortex Configuration screen.

System configuration

The configuration of a Corial system is set during manufacturing. Plasma-Therm engineers and authorized service personnel may adjust configuration settings when installing, testing or servicing the system. In most cases, configuration settings in Cortex should not be changed by end-users.

For authorized users and service engineers, the following sections describe how to review and save system configuration settings. A table at the end of the section describes all the settings on the System Configuration screen.

WARNING



Improper configuration settings can cause the system to malfunction. Only authorized personnel should be granted access to the Configuration screen. All users should log out of Cortex when they leave the system to prevent unauthorized access.

Reviewing system configuration settings

As a reference for qualified personnel, information on configuration settings is provided here. By default, the Configuration screen [security tag](#) is locked, so no user account except the Administrator account can select the Configuration screen button.

System configuration settings are organized on a series of tabs on the System Configuration screen. Click the **System** menu button and the **Configuration** screen button to display the System Configuration screen.

The screenshot shows the 'System Configuration' window with several tabs: System, Handler, PM1 Vacuum, PM1 Gas, PM1 RF, PM1 Temperature, and PM1 Misc. The 'Machine' tab is active, displaying the following settings:

- Name: Corial 200-IL
- System Type: Corial 200 Series
- Handler Type: Corial Load-Lock

Module	Type
AL	Installed
PM1	Installed

Other settings include:

- Language: English (with US flag icon)
- Pressure Unit: Torr
- Data Log Folder: C:\Cortex\Logs (with a 'Reset To Default' button)

The configuration of the system is specified on a series of tabs on the System Configuration screen.

Saving system configuration settings

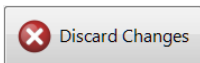
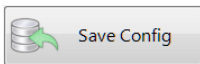

Changes to configuration settings must be saved, and in most cases, Cortex must be restarted for the new settings to take effect.

The **Save Config** and **Discard Changes** buttons become available when a configuration setting is changed. The buttons are not available if there are no unsaved configuration settings.

To save the current settings: Click **Save Config**. The info box shows a confirmation message. If Cortex must be restarted, a message box asks whether to restart Cortex now. Choose an option:

- To apply configuration changes: Click **Restart**. Cortex will close and restart.
- To continue without applying changes: Click **No**. The configuration settings will take effect after the application is closed and restarted.

To erase changes: Click **Discard Changes**. An Info box message confirms that original settings have been restored.

Importing a system configuration

A system configuration can be imported into Cortex to replicate the settings from an existing system.

When a system configuration is imported, Cortex imports the settings from all tabs of the System Configuration screen. It does not import user accounts, recipes, ACAP rules, or log files. Other data that is not imported includes job history data, previous leak tests, resource usage data. Tool settings are also not imported with a system configuration.

To import a system configuration

1. Click **Import** on the System > Configuration screen.
2. Select the configuration file to import and click **Open**. See "About Cortex configuration files" below for more information.
3. The Info box displays "Configuration file has been imported successfully" when the operation is completed. Click **Save Config** to implement the imported configuration.
4. Restart Cortex when prompted to do so to apply the new configuration settings.

About Cortex configuration files

The standard Cortex configuration file is named "Configuration.xml." This file is saved in the *Configuration* folder in the Cortex program folder. Cortex can import configuration files that have been renamed, as long as they are valid configuration files with the extension ".xml".

List of System Configuration tabs and settings

On the System Configuration screen, individual tabs contain the configuration settings for the subsystems. The specific options and settings on the tabs can vary, depending on the system components.

The following table lists each tab on the System Configuration screen, the settings on each tab, the available options, and brief descriptions of their purpose and effects. In the Options column, default values, where applicable, are underlined. Most of the listed settings apply to Corial systems in general, although some apply specifically to etching (ICP) configurations, as noted in the Description column.

Tab and settings	Options (default)	Description
------------------	-------------------	-------------

System tab

Name	<Text>	The entered text appears in the Status bar above the Cortex version number. Typically, this is a project number such as P800125, but can be any name the owner wants to display on the Cortex screen.
System Type	Corial 200 Series Corial 300 Series Corial 500 Series	Determines basic system components, availability of other system configuration options.
Chamber Type	RIE, ICP, ICP-CVD, PECVD	Determines default RF configuration
Handler Type	None Corial Load-Lock Hine SL	If "None," only manual material loading functions are available.
Language	English Francais - French Chinese Русский - Russian	Menu and screen buttons will appear in selected language (future implementation; only English available in version 1.0)
Pressure Unit	Torr Pascal Bar	Specifies the measurement unit for all pressure values in Cortex. Fractional units (mTorr, KPa, mbar) are used where appropriate.
Data Log folder	<Path to folder on system hard disk>	Default path is C:\<Installation folder>\Logs. Clicking the <i>Reset to Default</i> button replaces the current entry with the default path.

PM1 Vacuum tab

Pump Train: Startup State	Do Nothing Pump if Vacuum Always Pump Down	If "Do Nothing" is not selected, Cortex pumps down in all cases ("Always pump down"), or only if the chamber is already at vacuum when Cortex starts up ("Pump if vacuum").
------------------------------	---	---

Pump Train: Throttle Valve	None Corial	Configures the control interface for the throttle valve. The default is Corial.
Pump Train: Turbo Pump	Pfeiffer	Configures the control interface for the turbo pump. ICP chambers typically include a turbo pump.
Pump Train: Mech Pump Interface	Discrete I/O Pfeiffer	Configures the control interface for the mechanical pump.
Pressure Gauges: Size	<integer value>	The maximum pressure value of the process manometer in mTorr/mbar/Pa. Default value is 1000 mTorr.
Pressure Gauges: Safe Low Limit	<integer value>	Tithe minimum pressure allowed in the process chamber. Default value is 0 mTorr.
Pressure Gauges: Chamber Gauge	None PSG500	The type of the installed process chamber pressure gauge.
Pressure Regulation: MFC Size	Size in sccm (3,000)	

PM1 Gas tab

Gas Manifold: Channels 1 to 10, 13 or 17	None Purge Normal	Gas Manifold Size setting (10 or 13) determines number of gas channels. Additional settings for each channel: Name; Size in sccm; Default Tolerance; With Plasma Only.
Forbidden Pairs	(None)	Cortex prevents simultaneous operation of gas channels in "Forbidden Pairs" box.
Gas Manifold Size	10 Gas Lines 13 Gas Lines	Determines the number of configurable gas channels.

	17 Gas Lines	
Liquid Precursors	Channels 1 to 3	Available only on PECVD (deposition) chamber type. Settings for each channel are Name, size, and Default Tolerance.

PM1 RF tab

RF #1, RF #2, RF #3: Name	<Text>	The generator name displayed in Recipe Editor and Manual Mode screen.
RF #1: Type	AE Hilight 133 AE Hilight 136 AE Cesar 1310 AE Cesar 1320 Comet Cito Plus 1310 Comet Cito Plus 1330 Custom Power	All systems have RF #1. The Type setting determines default generator power levels.
RF #2: Type	None AE Cesar 0210 AE Cesar 0220 Custom Power	RF #2 is available only if Chamber Type is ICP. RF #3 is not implemented on any chamber type.
RF #3 Type		Available only with Dual-bias configuration
RF #1, RF #2: Max Setpoint	[Value in Watts]	Cortex limits RF power setpoint to the lower of the Max Setpoint and Safe Limit values. All generator types except Custom Power have Max Setpoint values that can't be changed.
RF #1, RF #2: Safe Limit	[Value in Watts]	Cortex limits RF power setpoint to the lower of the Max Setpoint or Safe Limit values.
RF #1, RF #2: Max Reflected	[Value in Watts]	Max Reflected power settings are determined by generator Type and cannot be changed.

RF #1, RF #2:	None	
Match Network Type	Corial RF / Corial ICP	Corial ICP is available only for RF #2 ICP type.

PM1 Temperature

Temperature Channels 1 to 3: Type	None Discrete I/O	The default configuration depends on the chamber type. Channel 1 is used on deposition chambers. Channel 2 is used only on etching systems.
Read Range Low/High	[Temp values in ° C.]	The lowest and highest temperatures the system can report to Cortex.
Set Range Low/High	[Temp values in ° C.]	The maximum setpoints that can be entered in the Recipe Editor and Manual Mode.
Safe High Limit	[Temp value in ° C.]	The highest temperature allowed before posting an alarm.
Tolerance Limit	[Temp value in ° C.]	The range beyond which a temperature is considered in or out of compliance with the setpoint, after the expiration of the Process Timeout (during processing) or the Stabilization Timeout (before leaving the Initial Step) period. The default value is 5° C. Example: At 5° C., the actual temperature is considered in compliance with the temperature setpoint for that channel if it is no more than 5 degrees higher or lower than the setpoint.
Startup Temp	[Temp value in ° C.]	The temperature Cortex implements when it starts.
Standby Temp	[Temp value in ° C.]	The temperature Cortex applies after the amount of time specified by the PM1/Temperature/Standby Time tool setting.
Safe Vent Limit	[Temp value in ° C.]	The temperature cannot exceed this value when an operator or a recipe requests venting of the chamber. If

the current temperature is higher, Cortex posts an alarm.

PM1 Misc

<p>Lift & Clamping Lift type Helium clamping type Manometer size MFC Size</p>	<p>Mechanical</p>	<p>Specifies if the process chamber is equipped with a mechanical material clamp, and has helium backside cooling. Standard ICP configurations have a mechanical clamp. Helium clamping is not available with PECVD chamber type.</p>
<p>Endpoint Detector</p>	<p>None EndpointWorks [version number]</p>	<p>Specifies whether EndpointWorks is to be used, and the EndpointWorks version. The IP address and port number must be specified for communication between Cortex and EndpointWorks. The default port number is 6216. The default IP address for PM1 is 192.168.2.120.</p>
<p>Enable System Parameters Service</p>	<p>(Not selected)</p>	<p>This option must be enabled if endpoint recipes refer to the values of process parameters, such as chamber pressure or throttle valve position.</p>

Configuration of gas channels

The "PM1 Gas" tab of the System Configuration screen contains the settings for the process module's gas channels. The settings include flow controller types, gas names, manifold size, and forbidden pairs.

To view or change the system's gas configuration, click **System > Configuration**, then click the "PM1 Gas" tab.

Gas channel settings

The "PM1 Gas" tab sets the hardware configuration of each gas channel. The number of channels in the box labeled "Gas Manifold" depends on whether "10 Gas Lines" "13 Gas Lines" or "17 Gas Lines" is selected in the "Gas Manifold Size" box.

The following settings specify the configuration of each gas channel. The configuration is shown visually in the diagram on the [Gas System](#) screen.

Channel: Sets the channel type as None, Normal, or Purge.

- None:** The channel is not configured, and the other gas channel settings are not available.
- Normal:** The channel has the standard Process Valve and Isolation Valve.
- Purge:** The channel has an additional purge valve and line, which allow flushing with nitrogen. A Flush step in a recipe can be used to purge these channels. The Flush duration is specified in the recipe step. The default duration is set by "Gas Flush Duration" under PM1/Maintenance on the Tool Settings screen.

MFC Type: This specifies the manufacturer of the mass flow controller (MFC). The available settings depend on the current hardware support. The default setting is "Horiba|MKS."

Name: Cortex uses the text in the Name box to identify gas channels, including on the Recipe Editor, Start Job, Gas System, and Manual Mode screens. The default name is "Gas" and a channel number. Two gas channels cannot have the same name. If more than one channel contains the same gas, they are usually distinguished by adding "a" or "b" to the gas name.

Size: The Size value specifies the maximum flow rate of the MFC in standard cubic centimeters per minute (sccm). Note that the actual maximum flow is affected by the gas channel's [calibration setting](#).

Default Tolerance: The value sets the allowed gas flow deviation from the setpoint, in sccm. This sets a range beyond which gas flow is out of compliance. A process recipe can override the default tolerance by changing the Tolerance value on the **Details** tab in the Recipe Editor.

With Plasma Only: This setting is available only if the chamber type is PECVD. Select the *With Plasma Only* checkbox to make Cortex prohibit the gas from flowing unless RF power is applied in the reactor.

Gas Manifold

	Channel	MFC Type	Name	Size (sccm)	Default Tolerance (sccm)
1	Normal	Horiba MKS	N2p	200	4.0
	Normal	Horiba MKS	O2	100	2.0
	Purge	Horiba MKS	CH4	100	2.0
	Purge	Horiba MKS	SF6	100	2.0
5	Normal	Horiba MKS	Ar	100	2.0
6	Normal	Horiba MKS	He	100	2.0
	Normal	Horiba MKS	N2a	100	2.0
	Normal	Horiba MKS	N2b	100	2.0
	None	Horiba MKS	Gas 9	100	2.0
10	None	Horiba MKS	Gas 10	100	2.0

Gas Manifold settings on the PM1 Gas tab.

Setting up forbidden gas pairs

In the Forbidden Pairs box, all gas channel names appear in the "Gases" box. Any pair of gas channels can be specified as a dangerous combination, or *forbidden pair*. Cortex prevents forbidden pair gases from flowing at the same time.

To specify forbidden pairs

1. Click two gas names in the Gases list to select them. The selected gas names are highlighted, and the Add button becomes available when two gases are selected.
2. Click **Add**. The selected gas names appear in the "Forbidden Pairs" box.
3. Repeat the previous steps to specify additional forbidden pairs.
4. Click **Save Config** to save the changes.
5. A confirmation message appears. Click **Restart** to close and restart Cortex.

To remove a forbidden gas pair

1. In the Forbidden Pairs box, select the gases pair, and then click **Remove**. The gas channel names disappear from the Forbidden Pairs list.

2. Click **Save Config** to save the changes. In the message box that appears, click **Restart** to close and restart Cortex.

Liquid precursor channels

When the chamber type is PECVD, the *PM1 Gas* tab includes three optional liquid precursor channels. Select the check box to configure each of the liquid precursor channels that is installed in the system.

The configuration settings for each channel are name, size, and default tolerance. When one or more liquid precursor channels is configured, the setpoints and actual values appear below the regular gas channels on the *Edit Recipe*, *Start Job*, and *Manual Mode* screens.

The *Service > Liquid System* screen provides direct access to the valves, flow controllers, and temperature settings of the liquid precursor channels. Like other Service screens, the controls are locked by default until a user clicks **Unlock Controls**. Context buttons on the Liquid System screen allow users to perform leak tests, and to flush and evacuate the liquid channels.

There are multiple temperatures zones for the liquid precursor system: one for each liquid canister, the MFCs, and the gas line to the reactor. The zones are labeled on the *Liquid System* screen, which shows the temperature setpoints and actual temperatures.

Tool settings for the liquid system are at *PM1/Liquid* on the Tool Settings screen. Settings include timeout for flow tolerance and temperature tolerance for all channels; tolerance and timeout for all temperature zones; and default temperature, high limit, and low limit for each temperature zone. If a specified temperature is not achieved, Cortex does not allow processing to start.

Liquid precursor flow also requires that RF power of at least 50 W is already on. Cortex also prevents liquid precursor flow if the door is open on the liquid channels enclosure.

Liquid Precursors			
	Name	Size (sccm)	Def. Toler. (sccm)
<input checked="" type="checkbox"/>	TEOS	100	2.0
<input checked="" type="checkbox"/>	TMB	100	2.0
<input type="checkbox"/>	Liquid 3	100	2.0

Two of the three possible liquid precursor channels are shown configured on the *PM1 Gas* tab of the System Configuration screen.

Tool settings

WARNING

Changing tool settings can severely impact the operation of Plasma-Therm tools. Untrained users should not have access to the Tool Settings screen. System administrators should change tool settings only as directed by qualified Plasma-Therm system engineers or technical support personnel.

To adjust settings for tolerances and timeouts, and to configure many aspects of system behavior, click the **System** menu and then the **Tool Settings** button to display the Tool Settings screen.

Who can view tool settings

The Tool Settings screen is not available to all user accounts. By default, the screen is available to the Administrator, Engineering, and Maintenance accounts. Tool settings with red text, as mentioned below, cannot be changed without a password.

To change a tool setting

In the Tool Settings list, select the setting to change, then do any of the following:

- **To set a new value:** Type in the Value box, or use the arrow buttons to increase or decrease a numeric value.
If the Password box is present, type the tool settings password. The Password box disappears when the password is entered.
- **To restore the default value:** click **Reset to Default**.
- **To save all current settings:** Click **Save Settings** in the left panel. The settings take effect immediately.

Navigating and selecting tool settings

The Tool Settings list is a tree structure that organizes settings into several categories. The following categories appear for a basic load lock system:

- **AL** contains settings for the load lock and material transfers.
- **PM1** includes timeouts and tolerances for process parameters.
- **System** includes settings for data logging, job IDs, and the signal tower.

On systems with multiple process modules, additional categories appear in the Tool Settings list. Each process module has its own tool settings (PM 1, PM 2, etc.). Other categories of settings are based on the configuration of the handling system and other system components.

Selecting items

Click to select a category or tool setting. You can use the arrow keys to change the selection. When a category is selected, all of its settings are listed in a table on the right. You must select an individual tool setting in the list (not the table) to be able to change its value.

When a tool setting item is selected, an explanation appears in the Description box. The lower box shows the current Value, with minimum, maximum, and default values shown for reference. A Password box appears if the value can't be changed without the password.

Showing and hiding items: To expand or collapse a category, click the plus [+] symbol, or press the Right and Left arrow keys.

Expand All displays all tool settings in all categories. **Collapse All** closes all categories except the one containing the selected tool setting.

Identifying default and protected settings

Indicators show which tool settings have special status:

- **Bold** indicates a setting has been changed from its default value.
- **Red text** identifies factory settings that are password-protected. The correct password must be entered on the Tool Settings screen. This password is not associated with any Cortex user account.

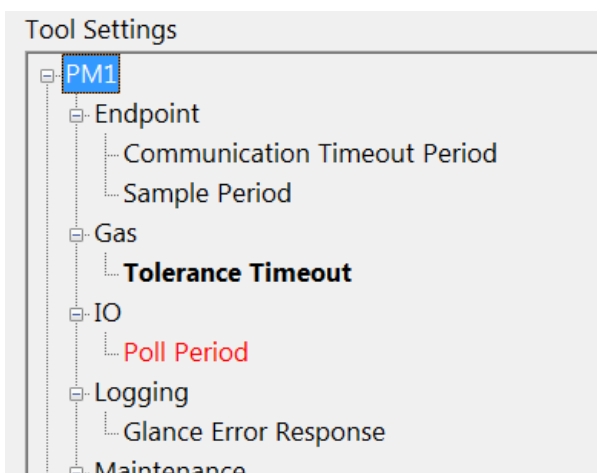

The Tool Settings list

The screenshot shows the 'Tool Settings' interface. On the left is a tree view with 'PM1' selected. The tree includes categories like Endpoint, Gas, IO, Logging, Maintenance, Process, RF, and Temperature. On the right, a 'Description' box contains the text 'All tool settings in the PM1 category.' Below it, a table titled 'PM1' lists various tool settings with their values and units.

Tool Setting	Value	Unit
Endpoint/Communication Timeout Period	5000	ms
Endpoint/Sample Period	1000	ms
Gas/Tolerance Timeout	5	seconds
IO/Poll Period	50	ms
Logging/Glance Error Response	Do Nothing	
Maintenance/Gas Calibration Duration	60	seconds
Maintenance/Gas Calibration Temperature	20	C
Process/Base Pressure Timeout	300	seconds
RF/Match Box Switch Delay	5	seconds
RF/RF Tolerance Timeout	5	seconds
RF/RF1 Default Reflected Tolerance	100	W
RF/RF1 Default Setpoint Tolerance	10	W

The Tool Settings screen describes the selected item. When a category is selected, all its settings are listed in a table.

Backing up tool settings

For disaster recovery of configuration information, tool settings can be saved to secure backup media. Saved settings can be copied to a new installation of Cortex to restore the system's settings.

Cortex saves settings in a file named "Tool Settings.xml" in the Configuration folder. The file format is XML, a plain-text format. Each time settings are changed, Cortex includes the time, date, and the logged-in user's name in the Tool Settings.xml file.

Factory automation commands and control states

Corial equipment can include an interface for factory automation under SEMI standards (SECS II and GEM E30). Special licensing, configuration, and software installation is required to enable factory automation; for details see "Factory Automation Requirements," below.

The following sections provide information about factory automation states, and configuration settings that affect factory automation, including communication addresses and port settings.

Specialized messages

Cortex supports several specialized messages. It also supports several custom commands for the Host Command Send (S2,F41) message. These are documented in the following sections.

Note: There are some differences in the Cortex factory automation interface on cassette-loading and manual-loading systems. All differences are noted in this documentation. For the complete factory automation documentation, see the *Cortex Factory Automation Interface Manual*.

S2,F41 — HCS (Host Command Send)

The Host Command Send message supports multiple commands. The message definition shows the structure and parameters of the message in SECS Message Language (SML). The commands are listed in a table that follows the message definition.

An S2,F41 message must include one of the commands listed in the first column of the table. The command is represented by <RCMD> in the message definition.

The S2,F41 message contains one or more name-value pairs, shown as <CPNAME> and <CPVAL> in the message definition. The commands table lists each <CPNAME> and the format of the <CPVAL> parameters. Some commands, such as START_JOB, can include multiple <CPNAME><CPVAL> pairs.

Message structure

Stream, Function Name (Mnemonic) Direction

S2,F41 Host Command Send (HCS) S, H -> E, reply

Description

The host requests the equipment to perform the specified remote command with the associated parameters.

Structure

- ```
L, 2
1. <RCMD>
2. L, n # of parameters
1. L, 2
1. <CPNAME1> parameter 1 name
2. <CPVAL1> parameter 1 value
.
.
n. L, 2
1. <CPNAMEn> parameter n name
2. <CPVALn> parameter n value
```

## HCS commands and parameters

The following table lists the commands that can be used for <RCMD> and the CPNAME parameters for each command . All parameters are ASCII data format. The "Supported systems" column notes if support is limited to some system types or configurations.

| Command (RCMD) | Supported systems      | Description and CPNAME parameters                                                                                                                                                                                                                                                                                                                                                          |
|----------------|------------------------|--------------------------------------------------------------------------------------------------------------------------------------------------------------------------------------------------------------------------------------------------------------------------------------------------------------------------------------------------------------------------------------------|
| START_JOB      | Cassette handlers only | <p>Defines a job for an entire cassette. This applies only to Odyssey systems with a cassette handler module.</p> <p><b>JOB_ID</b><br/>Alphanumeric text to assign to the job as an identifier.</p> <p><b>FLOW_NAME</b><br/>The flow to use for the job, in the form <i>Category/Flowname</i>.</p> <p><b>PORT_NAME</b><br/>Specifies the cassette port. Valid values are 'AL' or 'BL'.</p> |
| ABORT_JOB      | Cassette handlers only | <p>Aborts the currently executing job.</p> <p><b>JOB_ID</b><br/>The alphanumeric text label assigned to the job when it was started.</p>                                                                                                                                                                                                                                                   |

|               |                   |                                                                                                                                                                                                                                                            |
|---------------|-------------------|------------------------------------------------------------------------------------------------------------------------------------------------------------------------------------------------------------------------------------------------------------|
|               |                   | Implements the standby temperatures defined in Cortex.                                                                                                                                                                                                     |
| STANDBY_TEMPS | All               | <p><b>MODULE_NAME</b><br/>(ASCII) The process module identifier (PM1, PM2, etc.).</p> <p>Implements the temperature setpoints defined in a recipe.</p> <p><b>RECIPE_NAME</b><br/>The name of the recipe whose temperature setpoints are to be applied.</p> |
| RECIPE_TEMPS  | All               | <p><b>RECIPE_CATEGORY</b><br/>The category of the recipe specified by the RECIPE_NAME parameter.</p> <p><b>MODULE_NAME</b><br/>The process module identifier.</p>                                                                                          |
| NEXT_STEP     | All               | <p>Terminates the current recipe step and begins executing the following step in the current process recipe.</p> <p><b>MODULE_NAME</b><br/>The process module identifier.</p>                                                                              |
| PUMP_LOCK     | Load lock systems | <b>PORT_NAME</b><br>'AL'                                                                                                                                                                                                                                   |
| VENT_LOCK     | Load lock systems | <b>PORT_NAME</b><br>'AL'                                                                                                                                                                                                                                   |

## S2,F42 — HCS Reply

### Stream,Function Name (Mnemonic) Direction

S2,F42 Host Command Acknowledge (HCA) S, H <- E

#### *Description*

The equipment replies with acknowledgement of the HCS message. The reply message contains an overall acknowledgement code, and acknowledgements for each item.

### Structure

L, 2  
1. B1 <HACK>  
2. L, n  
L, 2  
A [CPNAME]  
V [CPACK]  
L, 2  
A [CPNAME]  
V [CPACK]

If there are no invalid parameters, a zero-length list is sent for item 2.

### Definitions

<HACK>

- 1 = <RCMD> command does not exist.
- 2 = Cannot perform now.
- 3 = At least 1 invalid parameter.
- 4 = Command will be performed.
- 5 = Rejected, already in desired condition.
- 6 = No such object exists.
- 7 = Other error, see debug log.

<CPACK>

- 1 = Parameter name <CPNAME> does not exist.
- 2 = Illegal value for <CPVAL>.
- 3 = Illegal format for <CPVAL>.
- >3 = Other equipment-specific error.

## S2,F71 Get Recipe List

The host can get a list of recipes stored on the equipment for a specified process module.

### Message structure

Stream,Function Name (Mnemonic) Direction

S2,F71 — Get Recipe List (GRL) S, H -> E, reply

#### Description

The host requests the equipment to send a list of recipes saved for a specified process module.

#### Structure

1. <PMNAME>

### Definitions

<PMNAME> (ASCII): The process module identifier. The message must specify only one PM, in the form "PM1" for the first process module (Odyssey and Navigator), or "PM2" for the second process module (Odyssey only). The <PMNAME> is included in the reply message.

## S2,F72 Recipe List Reply

### Stream,Function Name (Mnemonic) Direction

S2,F72 — Recipe List Reply (RLR) S, H <- E

### Structure

(B) <GRLACK>  
(A) <PMNAME>  
[L, n]  
<RECI PENAME<sub>1</sub>>  
<RECI PENAME<sub>2</sub>>  
.  
.  
<RECI PENAME<sub>n</sub>>

### Definitions

<GRLACK>

0 = Success; message contains the recipe list.

1 = Wrong message format (such as two PMs specified).

2 = PM not found.

n is 0 if GRLACK is not zero.

<RECI PENAME> (ASCII) For recipes in the Production, Engineering, and Experimental categories, RECI PENAME is in the form <category>/<recipe>. For recipes in the Personal category, RECI PENAME is in the form <username>/<recipe>. For example, "Production/Recipe1" and "User1/Recipe1".

The RECI PENAME list is sorted alphabetically by category or username, then by recipe name. Archived recipes are not included in the list of recipes in the reply message.

## Factory automation requirements

Factory automation capability is an optional feature of Cortex. The following sections give an overview of the Cortex user interface related to factory automation. It describes status indicators, settings, and where to find additional information.

### SECS/GEM security key

Cortex requires a hardware security key to enable communication with a factory automation host. The security key must be installed in a USB port of the Cortex computer. When Cortex starts, the following error messages appear if the security key is missing or is not detected:

- License Manager: No License Found (RC1)! Please register the product with License Manager first!
- GEM Error: Could not initialize SecsToHost.net
- GEM Error: Could not initialize GEM Interface! Check log file for details.

### Configuration settings

Factory automation settings are in the SECS/GEM box on the System tab of the System Configuration screen. "Installed" must be selected to enable factory automation. The initial communication state and initial control state are selectable; these states are described below.

**Note:** Factory automation support is not available on all tool platforms. Licensing, configuration, and software installation is required to enable factory automation capability. For additional information about factory automation, contact Plasma-Therm technical support or your sales representative.

## Control and communication states

Cortex displays status information for factory automation in two places:

- The GEM Status screen displays state and system information. It contains buttons to change communications and control states.
- The Host icons in the Status bar also indicate communications and control states. An alert icon appears when a message is received.

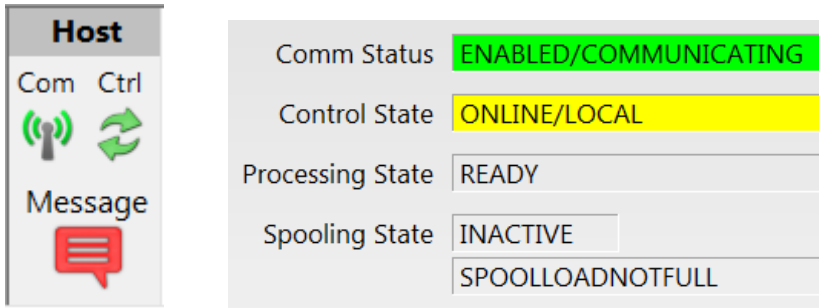

Icons show GEM states in the Status bar (left). State messages appear on the GEM Status screen (right).

## Communications state

The Communications State Model is a part of the GEM standard. For more information on the various states, triggers, and transitions, refer to the state model diagram in the Cortex factory automation guide and the SEMI documentation for the E-30 (GEM) standard.

On the GEM Status screen, the "Comm Status" box shows the current communications state. The color of the radio waves in the "Com" icon indicates the current communications state:

**Enabled/Communicating** (green): The communication state is Enabled and Communicating.

**Enabled/Not Communicating** (yellow): The communication state is Enabled, but not connected.

**Disabled** (gray): The communication state is Disabled. Communication is not possible unless Cortex is restarted.

## Control state

The Control State Model is a part of the GEM standard. For more information on the various states, triggers, and transitions, refer to the state model diagram in the Cortex factory automation guide and the SEMI documentation for the E-30 (GEM) standard.

On the GEM Status screen, the "Control State" box show the current control state. The "Ctrl" icon in the status bar is colored to indicate control state.

**Online/Remote** (green): The equipment is online in Remote control state. The status bar "Ctrl" icon is green.

**Online/Local** (yellow): The equipment is online in Local control state. The status bar "Ctrl" icon is yellow.



**Offline/Attempt Online** (yellow): The equipment is offline and the host requested changing to online.

**Host Offline** (yellow): The host has sent an S1,F17 message requesting the Offline control state.

**Equipment Offline** (gray): The equipment is offline and has not received a message requesting the change to online. The status bar "Ctrl" icon is gray.

## Terminal message indicator



A blinking red icon appears under "Message" in the Status bar when Cortex receives a terminal message from the host. Click the icon to display the message on the GEM Messaging screen. The screen shows the date and time a message is received. The indicator continues flashing until an operator clicks **Acknowledge** on the GEM Messaging screen. The message text remains until it is replaced by another message or Cortex is restarted.

## Changing communication and control states

The control state determines whether Cortex accepts commands entered by the system operator through the user interface only, or also accepts commands transmitted by the factory automation host using SECS-II messages.

In the Remote control state, Cortex accepts commands from the factory automation host.

In the Local control state, Cortex accepts commands only through the user interface. Cortex rejects commands from the host that would cause action or change settings. This includes commands to start jobs, to rename material, and to change equipment constants, for example.

In Local mode, Cortex can receive Terminal messages sent by the host, and can transmit Terminal messages to the host. Cortex responds to requests for the names or values of variables, including status variables.

In Local mode, Cortex also accepts S1,F13 messages from the host to change the control state from Local to Remote.

## Using command buttons

Command buttons in the left panel of the GEM status screen can change between Online and Offline communication state, and between Local and Remote control modes.

**Go Offline / Go Online:** This command button toggles Cortex between active communication ("Online") with the factory automation host, and stopping communication with the host ("Offline"). When the state is "Equipment Offline," the host can send an S1,F13 message to change the control state to "Online/Remote."

**Remote Mode / Local Mode:** This command button toggles between the Local control mode and Remote control mode. If the control mode is Local, the host can send an S1,F13 message to change the control state to "Online/Remote."

## Factory automation configuration

For the Cortex factory automation interface to be active, a configuration setting is required. The "Installed" option must be checked on the System tab of the System Configuration screen. In addition, two settings determine the initial communication and control states when Cortex starts.

**Initial Comm State:** The valid settings are Enabled and Disabled. To connect with a factory host, select Enabled.

**Initial Control State:** For Cortex to accept factory automation commands, Initial Control State must be "Online/Remote." When the setting is "Online/Local," communication is enabled, but the host cannot initiate actions on the equipment. Only terminal message transfer between the host and Cortex, and S1,F13 messages to establish communications and change to Remote control mode, are allowed.

## Settings in the 'Gem Interface.xml' file

In addition to the Configuration screen in Cortex, settings and variables related to factory automation are contained in a file named "Gem Interface.xml." The file is in the Configuration folder in the Cortex program folder. The Cortex program folder is typically at C:\Cortex on the system's main computer.

The Gem Interface.xml file contains several settings related to communication between Cortex and factory automation hosts. The following settings determine protocol and communication port:

- Protocol:** HSMS is the high-speed messaging service protocol used by Cortex. The factory host must use HSMS protocol.
- LocalPortNumber:** This setting specifies the communication port that the factory automation host uses to communicate with Cortex. The default setting is port 15500. The port setting can be changed, as long as the host uses the specified port. To the host system, this is the remote port.

Gem Interface.xml also contains all constants and variables supported by the factory automation interface. Specifically, the file lists the IDs for all status variables (SVIDs), equipment constants (ECIDs), data variables (DVIDs), collection events (CEIDs), reports (RPTIDs), and alarms (ALIDs).

When Cortex starts, it reads the Gem Interface.xml file. Cortex does not make any changes to this file. If the Gem Interface.xml file is changed outside of Cortex, such as to change communication settings or variables, Cortex must be restarted for the changes to take effect.

**Note:** Gem Interface.xml includes Initial Control State and Initial Communication State settings. However, Cortex implements these settings from the System Configuration screen if they differ from the settings in Gem Interface.xml.

## Additional documentation

Standard factory automation messages that are supported by Cortex are documented in the *Factory Automation Interface Manual*. The manual lists all events, status variables, reports, and alarms that are supported in Cortex. It also includes the SEMI E30 GEM State Models, capabilities, and scenarios that are supported by Cortex.

**Note:** Standards for factory automation, including E30 (GEM) and E5 (SECS-II), describe many aspects of factory automation that are supported by Cortex. The SECS/GEM standards are published by [SEMI](#), a semiconductor industry association. Refer to these documents for general information about factory automation and SECS/GEM standards.